

RADIO

*and
Television*

RETAILING

MAY • 1940

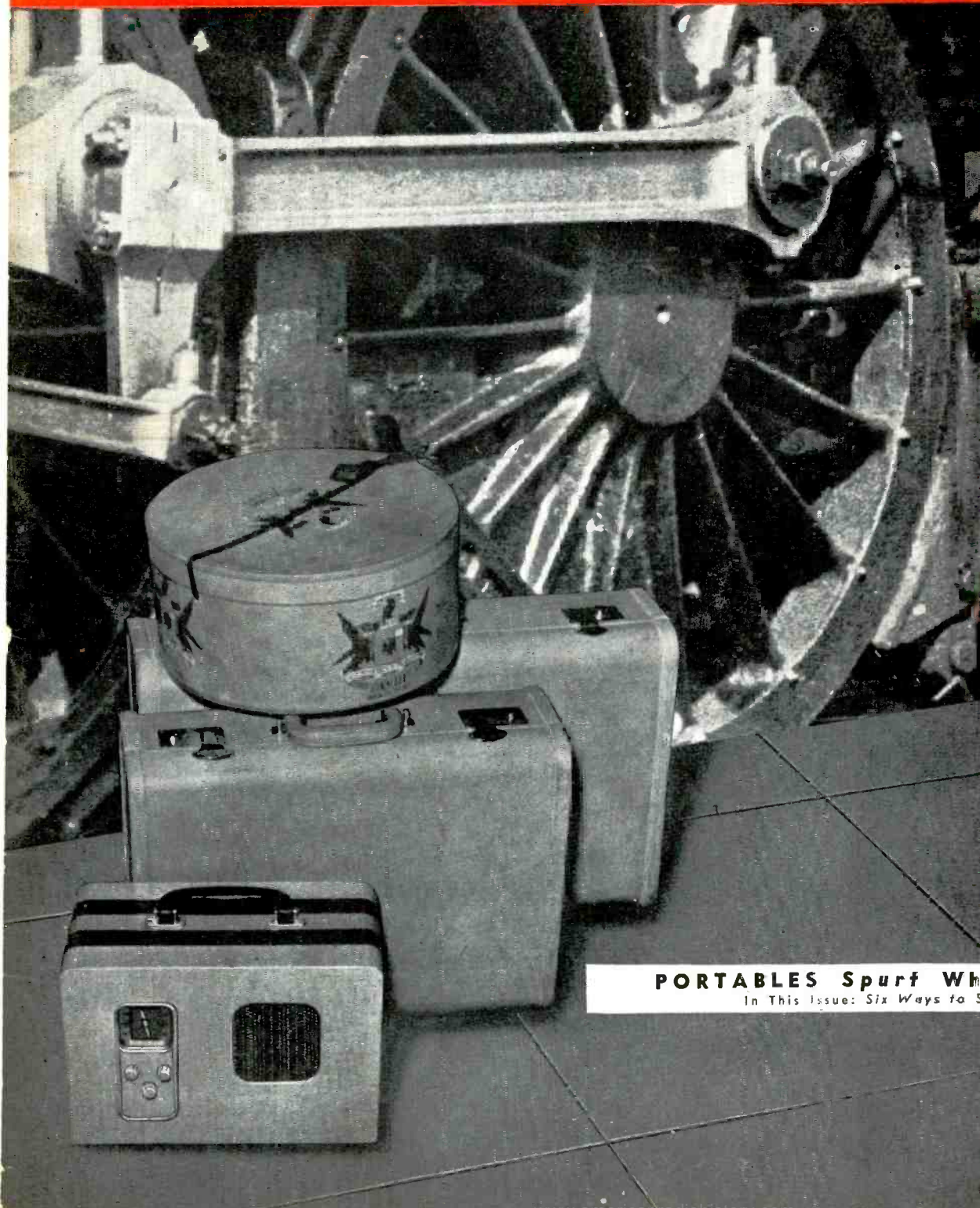

F-M SALES AND SERVICE

TELE TEST REPORT

BUILT-IN BLUEPRINTS

RECORDING TIPS

TYPICAL STORE FIGURES

HANDLING SOUND TRACKS

RECORD DISPLAY IDEAS

REFRIGERATION AIDS

NEW PRODUCT PICTURES

ON THE NEWSFRONT

LATEST CIRCUITS

TUBE DATA

PORTABLES Spurf When TRAVEL Starts

In This Issue: Six Ways to Stimulate Summer Sales

A
McGRAW-HILL Publication

Price 25c

**For
Precision Replacements...**

**Depend on
P. R. MALLORY & CO. Inc.
MALLORY
VIBRATORS**

Along every practical front, Mallory has pioneered in standardization in order to safeguard the radio service engineer against a needlessly growing variety of sizes and types.

Never-the-less, varying loads and circuit applications require different designs in order to secure maximum efficiency and customer satisfaction. In each such case these needs are exactly met. Mallory offers no "cure-all" solution to vibrator replacement.

Mallory Vibrators are original equipment in

practically 80% of all present auto and other battery-operated radios. They have achieved this position through dependability and long life. Mallory Vibrators for replacement are equal, or superior in construction and quality to the vibrators used as original equipment. In the case of each replacement, you can be sure of the *right* vibrator for each set.

You can stake your reputation on the performance of Mallory Vibrators . . . yet they cost no more.

Just a few copies left!

Thousands of radio service engineers are saving time and money on every auto radio . . . and every battery-operated household receiver job with this Mallory Replacement Vibrator Guide. If you haven't gotten your copy

Ask your distributor today...

It's FREE



P. R. MALLORY & CO., Inc.
INDIANAPOLIS INDIANA
Cable Address—PELMALLO

*Insist on the best
...they cost no more*

Use
P. R. MALLORY & CO. Inc.
MALLORY
APPROVED
PRECISION PRODUCTS

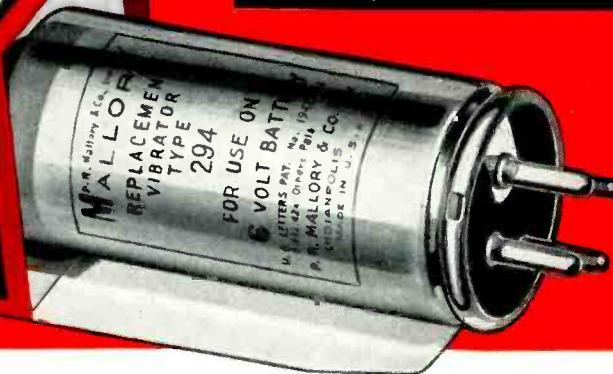
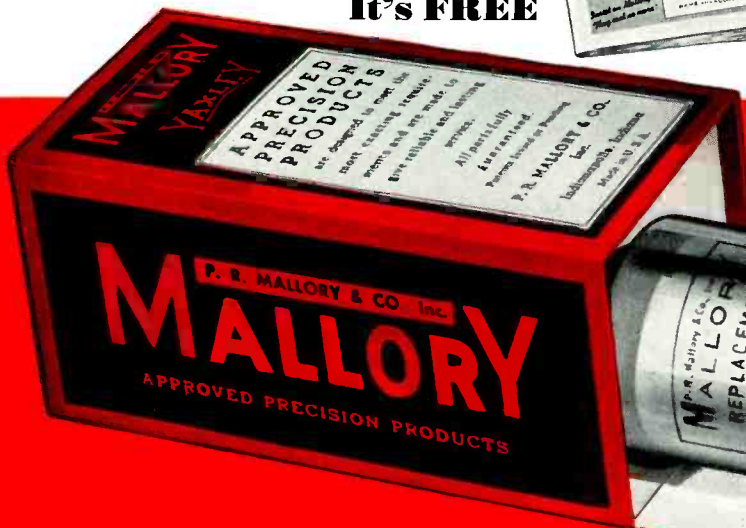

RADIO and Television RETAILING

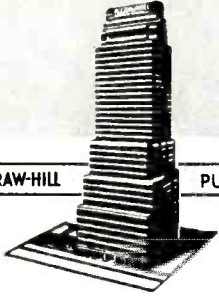

A McGRAW-HILL

PUBLICATION

MAY 1940

W. MacDONALD Editor
 C. A. NUEBLING Technical Editor
 C. DORF Assistant Editor
 A. XIQUES Assistant Editor
 HARRY PHILLIPS Art Director
 •
 LEE ROBINSON Manager
 R. E. McGRAW Sales Promotion Manager
 K. R. GROENER Western Manager

McGRAW-HILL PUBLISHING COMPANY, INC.

JAMES H. McGRAW
 Founder and Honorary Chairman

Publication Office
 99-129 North Broadway, Albany, N. Y.
 Editorial and Executive Offices
 330 West 42nd Street, New York, N. Y.

Cable Address: MCGRAWHILL, New York
 Member A.B.P. Member A.B.C.

James H. McGraw, Jr. President
 Howard Ehrlich Executive Vice-President
 Mason Britton Vice-Chairman
 B. R. Putnam Treasurer
 D. C. McGraw Secretary
 J. E. Blackburn, Jr. Director of Circulation

RADIO and Television RETAILING, May, 1940.
 Vol. 25, No. 5. Published monthly, price 25c
 copy. Subscription rates—United States and pos-
 sessions, Canada, Mexico and Central American
 countries, \$1. All other countries \$2 a year or
 twelve shillings. Printed in U. S. A. Entered as
 Second Class Matter, April 29, 1939, at Post
 Office, Albany, N. Y., under the Act of March 3,
 1879. Cable address "McGrawHill, New York."
 Member of A.B.P. Member of A.B.C. Copyright
 1939 by McGraw-Hill Publishing Co., Inc., 330
 West 42nd Street, New York, N. Y.

Branch Offices: 520 North Michigan Ave., Chicago;
 68 Post St., San Francisco; Aldwych House,
 Aldwych, London, W. C. 2; Washington; Phila-
 delphia; Cleveland; Detroit; St. Louis; Boston;
 Atlanta, Ga.

AUDIO AND VIDEO	What the Editors Hear and See	13
AT THE IVANHOE	Where Recording Earns Its Salt	15
SALES PHOTOSHORTS	Ideas in Pictures for Busy Men	16
F-M NEWS FOLLOW-UP	More About the Merry-Go-Around	18
PORTABLES FOR SUMMER	How to Make the Most of Them	20
FIGURES CAN FOOL YOU	Compare These with Your Own	22
BUILT-IN RADIO	Wiring Plans, Profitable Extras	24
TELE SALES TIPS	You'll Want Them Today or Tomorrow	26
SERVICEMEN WANTED	One Way to Duck Competition	28
RECORDS ON DISPLAY	Four Practical Suggestions	29
HANDLING SOUND TRUCKS	How to Make Them Pay	30
START RECORDING	Man Making Money Tells You How	32
SELLING REFRIGERATION	It's Easier If You Know How	34
NEW PRODUCTS	Latest to Buy and Sell	39
ON THE NEWSFRONT	What's Going On in the Business	47
CIRCUITS OF THE MONTH	Keeps Technicians Up to Date	61
SERVICING F-M	You'll Want to Read Closely	65
SHOP SHORTCUTS	Facts It Pays to File	68
TRICKS OF THE TRADE	Typical Troubles Spotlighted	70
YOU TELL US	Letters From Our Readers	72



SALES STATIC . . . You know I'm somewhat of a serviceman, myself—
 I nearly had it fixed!

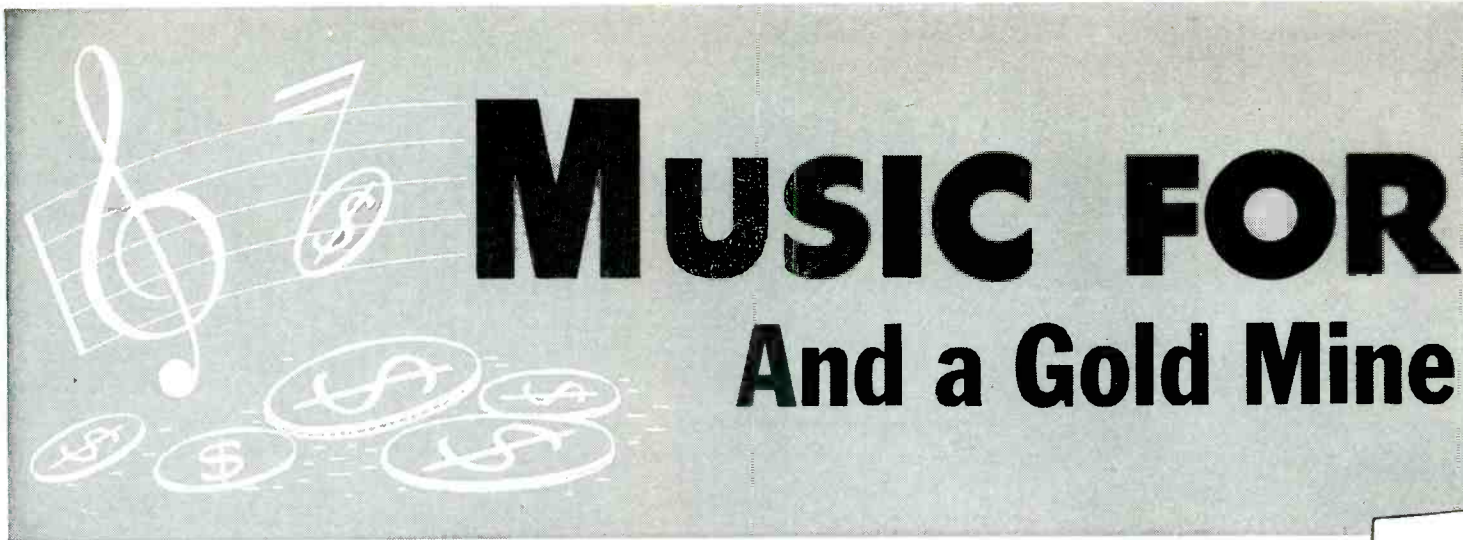

New Victor Black Label Classics

*Musical masterpieces by world famous artists
in popular editions at popular prices*

RCA Victor opens the World's Greatest
Treasure House of Music to the mass market
...with fine recordings for as little as

75¢

GET IN on the ground floor of this sensational new Victor Record merchandise opportunity. For the first time in Victor history, the world's finest music—performed by world famous artists—at the lowest prices in Victor history.

Victor Black Label Classics are superb, newly pressed electrical recordings. They are made from carefully preserved "master" records whose numbers have been withdrawn from the catalogue to make way for new monthly releases. Each record is a splendid performance. Music lovers can double their record libraries and you can double your Victor Record sales!

*Music Everybody Loves
... Names Everybody Knows—at unheard
of prices!*

Immortal compositions of the great masters—many of music's most magical names are included in the new Victor Black Label Classics. Beethoven—Brahms—Tchaikowsky; Kreisler—Barbirolli—Rubinstein—and others, equally notable, equally desirable, definitely saleable—with more to be added! At 75c for 10-inch records and \$1.00 for 12-inch records, Victor opens its music treasury to more millions—opens a gold mine to RCA Victor dealers!

more ^ MILLIONS for You!

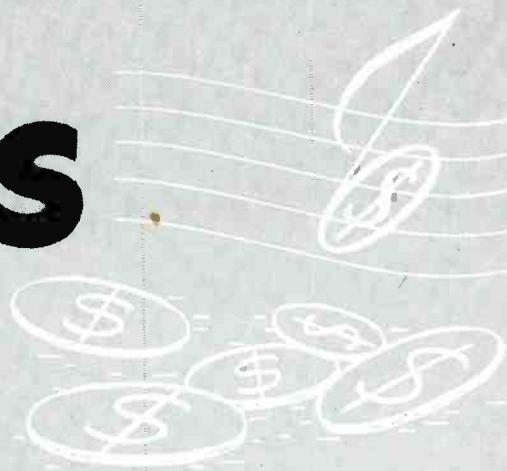

BRINGING THE WORLD'S GREATEST TREASURE HOUSE OF MUSIC TO ALL

VICTOR

offers magnificent musical masterpieces performed by the world's greatest artists at prices as low as

75¢

Now you can double your Record Library



SELECT YOUR FAVORITES FROM THESE VICTOR BLACK LABEL CLASSICS

- Tell me and I shall die—Isabelle Lohde's Love-Drach 20567 75¢
- (Singer) Maria Jeritza (Vienna) 20568 75¢
- Paula Vales (The Spanish) (Austria) 20569 75¢
- Amelie Galli-Curi (The Sorcerer) 20570 75¢
- Eine Kleine Nachtmusik—
- (Singer) John Gatti (Vienna) 20571 \$1.00
- The World is Waiting for the Sunrise (Lockhart) 20572 75¢
- Rose in the Bud (Foster) Herald Werrenbach 20573 75¢
- Polonaise in E Flat Minor (Chopin) Op. 26, No. 2 Ignace Jan Paderewski 20574 75¢
- Caprice Viennois (Schubert) 20575 75¢
- Leads (The Coblers) (Sarasate) Yehudi Menuhin 20576 75¢
- Romance—
- Halle Minor (Schubert) 20577 75¢
- Larghetto (Wagner) with Mrs. Kreisler—Violin, with M. Raabenstein at Piano 20578 75¢
- Mazurka (The Day) (Liszt) Back in My Arms a Surrender (Grieg) Benjamin Gliss Sorrento (De Curtis) Benjamin Gliss 20579 75¢

Victor Black Label Classics Complete in Attractive Albums

- Symphony No. 40, in G Minor (Mozart) Chicago Symphony Orchestra, under the direction of Frederick Stock. Album G-2, 6 sides. Price \$3.25
- The Nutcracker Suite (Tchaikovsky) London Philharmonic Orchestra, conducted by Eugene Cosens. Album G-3, 6 sides. Price \$3.25
- Symphony No. 8, in B Minor ("Unfinished") (Schubert) Vienna Philharmonic Orchestra, conducted by Bruno Walter. Album G-4, 6 sides. Price \$3.25
- Concerto in A Minor (Grieg) Arthur Schnitzler (Haug) and The Royal Albert Hall Orchestra, conducted by Sir Donald Hall. Album G-5, 6 sides. Price \$3.25
- 10-inch Records, 75¢
- 12-inch Records, \$1.00

THINK OF IT!—genuine Victor Records, the world's finest music played and sung by world famous artists, now obtainable at all-time low prices. This means that now you can own many more of your favorites—great orchestral works, glamorous opera music—a whole library of masterpieces at a fraction of the cost. Victor Records enjoy an enthusiastic public acceptance which makes it necessary to issue an extensive list of new selections each month. To make way for these new additions, certain fine recordings must be artfully withdrawn from the catalogue. However, the "master" records, the ones which have increased public demand, and now, on the basis of widely increased public demand, are being reissued in new editions, it is possible to issue these fine records in popular editions—popularly priced.

Today, Victor offers the New Black Label Classics... superb, newly pressed electrical recordings at prices never before known for Victor Records of this quality! Listed on this page are the first group of selections chosen. They will be augmented by others of equal importance as time goes on.

Now—more than ever—you can enjoy the music you have longed for in recordings of renowned Victor excellence, and at hitherto unheard-of prices. Visit your RCA Victor Music Merchant and hear these marvelous records. Give yourself the satisfaction and pleasure of choosing from Victor Black Label Classics the glorious music you have always wanted to own.



NEW VICTOR Black Label CLASSICS
A SERVICE OF THE RADIO CORPORATION OF AMERICA

Advertisement on Victor Black Label Classics ran as a full page in 44 cities, as a half-page in 24 cities

Small in this reproduction—but smashing in effect—this dramatic full page advertisement is scheduled to sound the clarion call to Victor Record customers in the key cities of the country. Half-pages, too—and co-operative advertisements that will put the story across in your community—with compelling effect!

CLEAR THE DECKS

Get ready for the rush in your Record Department

Victor Black Label Classics are timed to the minute for tremendous popular appeal. They're bound to send your sales surging up to new highs. Supplementary musical merchandise will benefit as well.

Call on your RCA Victor distributor for the complete details on this marvelous opportunity. Ask about the co-operative ads and merchandising helps now ready.

NEW VICTOR Black Label CLASSICS

A Service of the Radio Corporation of America



P.R. MALLORY & CO., Inc. MALLORY

The *One* Line That Gives You *All* The Answers On Condenser

Mallory gives you every answer to condenser replacement because the entire line has been developed around an exhaustive study of millions of condensers now in use...and the experience gained in supplying millions of condensers to leading manufacturers for use as original equipment.

It is no idle boast to say that no manufacturer gives you a condenser line with wider replacement possibilities.

For inexpensive, compact receivers Mallory provides Tubular Condensers with over 50 ratings to choose from... with common anode, common cathode and separate sections too.

Mallory FP (Fabricated Plate) Capacitors bring a new high in efficiency and performance. Millions are in use as original equipment. FP Capacitors give you

Replacement

features not duplicated in any other condenser. Smaller sizes, unusually low R.F. impedance, surge-proof construction, improved seal against heat and humidity... these are just a few.

Mallory Type TP (paper)... and Mallory Wet Electrolytic Condensers are equally dependable... equally adapted to efficiently meet the service requirements for which you need such replacements.

Decide now to solve your condenser replacement problems by depending on Mallory. It costs no more. You'll get tops in service from Mallory selected, nation-wide distributor setup.



Use
P.R. MALLORY & CO., Inc.
MALLORY
APPROVED
PRECISION PRODUCTS

P. R. MALLORY & CO., Inc.
INDIANAPOLIS INDIANA

Cable Address—PELMALLO

Fine Musical Instruments



Since 1902

Seeburg

AUTOMATIC RECORD CHANGERS

AND RECORDERS

CHOSEN PRECISION
EQUIPMENT FOR THE
FINE PRODUCTS OF
AMERICA'S FOREMOST
RADIO MANUFACTURERS

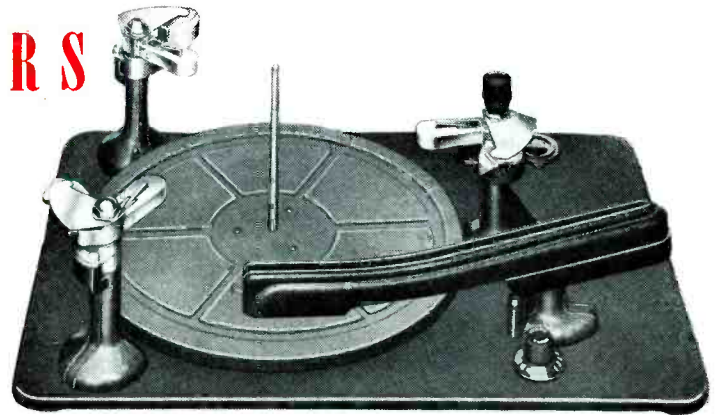

SEEBURG AUTOMATIC RECORD CHANGER MODEL "H"

Plays fifteen mixed 10" and 12" records—gravity type. Guide arm and lifter cam feature permits playing of extremely warped records. Three-point suspension with two oilless bearings in each post. Play-Meter can set to play from 1 to 15 records or repeat a record up to 15 times, then stop automatically. Tone Arm is in extreme outward position when stopped automatically. No need to lift off record when re-loading, one control knob turning blades and arms to re-loading position. Pressure on Play-Meter knob rejects record.

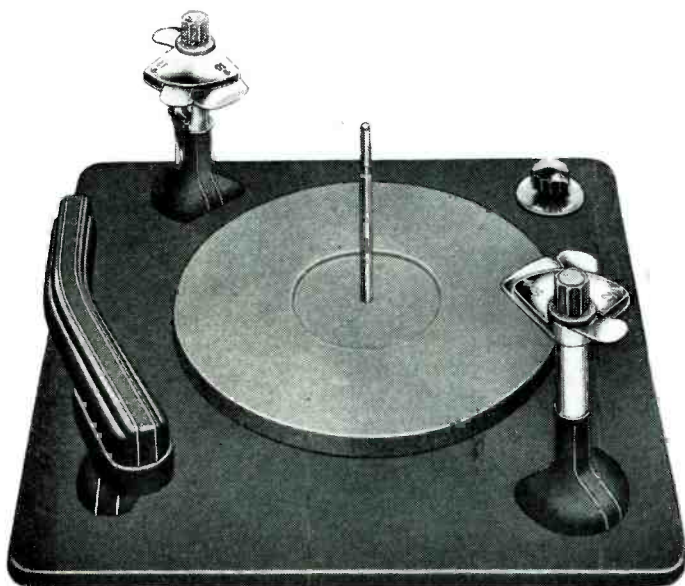

SEEBURG AUTOMATIC RECORD CHANGER MODEL "J"

Compact; 14" long, 14" wide, 3" deep. Handles 14 ten inch or 10 twelve inch records, gravity type. Two post suspension. No screws or brackets on top surface. Simplest changer mechanism. Long main bearing, ball thrust. One control button for all operations. Rigid counterbalanced pickup arm with crystal cartridge. Selector blades will not chip or break records. Needle pressure, 2½ oz. Handles warped records and all commercial thickness variations. Tone Arm, held in outward position by latch under panel, automatically released by starting switch.

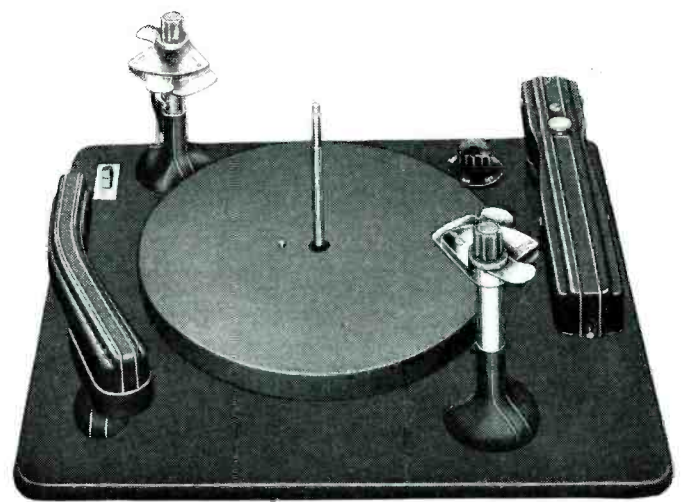

SEEBURG RECORD-O-MATIC

Has all advantages of Model "J" Changer. In addition: Cutting head assembly contains no steel stampings—all parts cast for rigidity; hardened cone bearings at all essential points; lead screw has support bearings at each end; larger main bearing and ball thrust to carry weighted turntable; 1¼ oz. pressure crystal pickup in aluminum tone arm gives long record life; crystal or magnetic cutting heads; cutter has plunger type, automatic engagement with lead screw; separate switch for manual play-back frees Tone Arm from automatic mechanism—any size record may be played manually.

J. P. SEEBURG CORPORATION • 1500 DAYTON STREET • CHICAGO



RECORDERS ARE SELLING!

THE SMASH HIT TODAY IS THE

Federal RECORDING RADIO

2 AMAZING HOME MODELS



The **CONSOLE**

Here they are—two of the most thrilling, versatile, actually amazing packages of home entertainment that ever appeared on the radio dealer's floor. They're a veritable bomb of sales excitement wherever shown.

"The thrill of hearing your own voice come back to you—talking or singing! The voices of your children, relatives or friends... baby's first word...

Johnny's first cornet solo..." Never have you had an instrument to sell that will literally panic the prospect's "must have" mood as this one feature of the Federal Recording Radio will do.

Add to this the ability to make your own record library from radio programs,—plus all that the finest 9-tube radio has to give,—plus a phonograph of supreme reproducing quality,—plus a home broadcaster, amplifying music or voice at home, at parties, at meetings,—and all this at a price in line with standard radio-phonograph combinations, and you have a presentation that you can't stop selling. This is the most sensational release in the history of the radio-phonograph business, destined to quickly revolutionize the entertainment equipment in millions of American homes.

With the console model, illustrated above, you can make permanent, lasting recordings (on 6, 6½, 8, 10 or 11-inch disks) of any radio programs or anything spoken, sung or played into the sensitive microphone. You can record from the air and over the microphone simultaneously. Recordings can be played back immediately. The latest development in cutting mechanism and a special microphone pre-amplifier stage gives exceptional microphone sensitivity. The console has convenient push-buttons for easy control of radio, phonograph, home broadcasting, microphone and off-the-air recording. Has high fidelity, 9-tube radio receiver with push-button tuning and full-size, 12-inch speaker, special equalized output and pickup circuits and push-pull output tubes, assuring the finest in short wave and domestic reception. Phonograph gives perfect reproduction of records up to 12-inch with lid closed. The efficient home broadcaster multiplies its importance as its many uses are considered. The cabinet is beautiful hand-rubbed walnut finish. Desk stand, super-sensitive microphone and cord.

The **Popular TABLE MODEL**

The table model, right, has the recording, radio, phonograph and home broadcaster features of the console, cuts records in the same sizes and will play up to 12-inch records with lid closed. Both radio and phonograph give the very finest in reception and playback, the cabinet being ample size for full bass response. Beautiful hand-rubbed walnut finish. The Federal Recording Radio Table Model is priced for popular sale and has already aroused amazing reception wherever shown.



2

MODELS FOR PROFESSIONAL AND SCHOOL USE

FEDERAL RECORDERS FOR EVERY PURPOSE



The Symphonic Model Federal Recorder, designed for professional use, incorporates many new and exclusive features. Records on all size disks up to 16-inch. Overhead, fully adjustable cutting head. Speed-governor turntable. Records over microphone and radio simultaneously. Operates at 78 or 33½ RPM. Complete with dynamic microphone, floor stand and cord.



The Little Pro Federal Recorder is the ideal, moderately-priced, portable machine. Makes records up to 12-inch. Has two speeds, overhead, fully adjustable cutting head, steel alloy turntable, and will record voice, music, and radio programs simultaneously. Complete with high grade crystal microphone, desk stand and cord.

100

Write at Once for Complete Details of the Federal Dealership and Name of Your Nearest Distributor

50 West 57th Street **FEDERAL RECORDER COMPANY, INC.** New York, New York

Dept. 5110

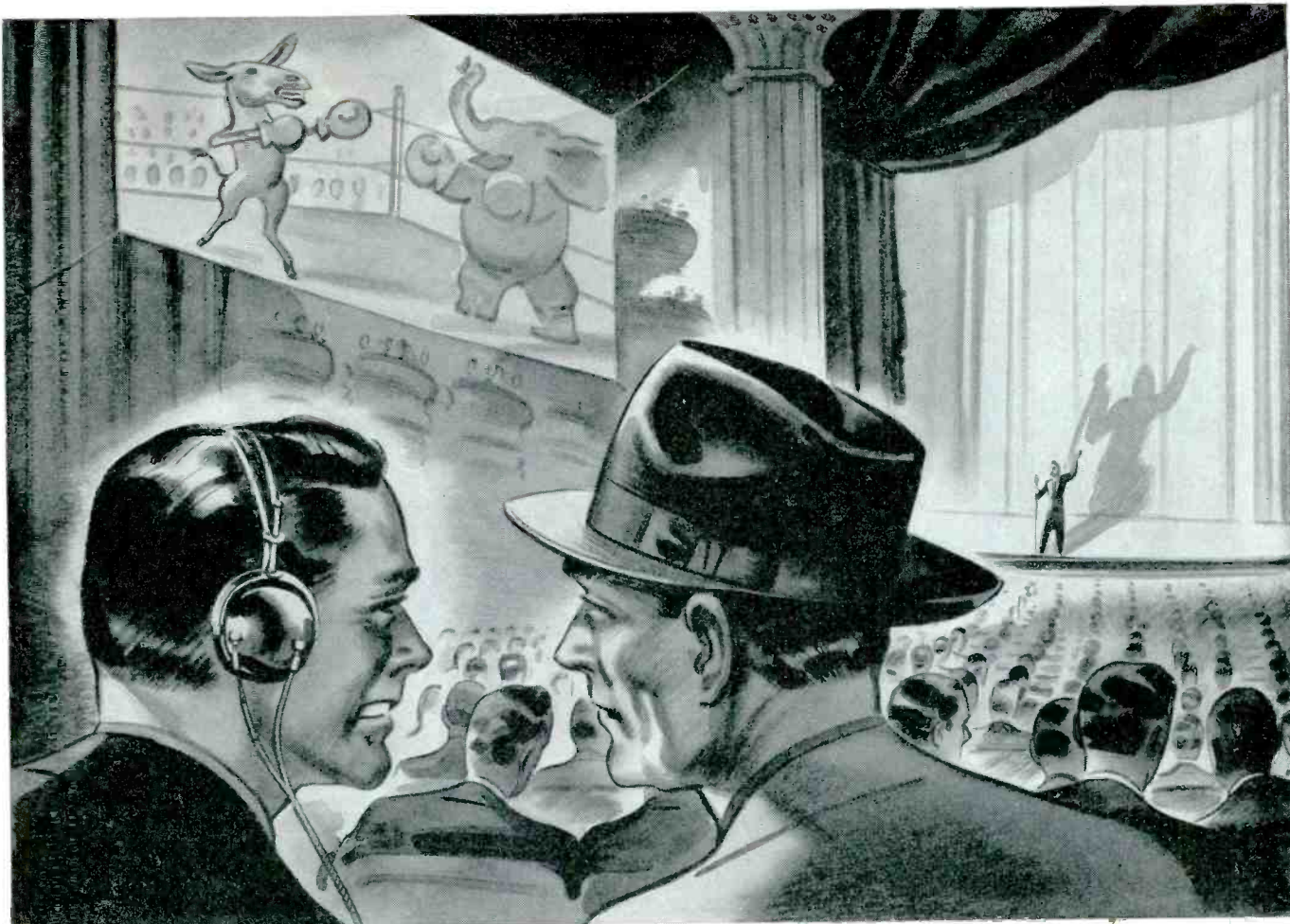

"HE SAYS THEY SHOULD HAVE USED UTAH SPEAKERS"

The heated words of thousands of politicians are being added to the normal output of the nation's sound equipment systems. New public address facilities are being installed in increasing numbers. And the demand is growing by leaps and bounds.

Sound equipment men know that the profit possibilities are *big* IF the system is "right." One way to be sure of maximum profit is to standardize on Utah's high fidelity speakers specially engineered for high power public address systems.

Utah public address system speakers give you, in addition to many others, these outstanding features:

1. Special Utah phenolic resin cement treatment provides an extra sturdy voice coil, assuring maximum safety under **EXTREME OVERLOADS**.
2. Completely dust-proofed.

3. All cementing operations completely cured before final test, assuring perfect centering, made possible by THE MODERN METHOD —use of THERMO-PLASTIC cements throughout.
4. Rugged formed-steel cone housing for maximum strength and rigidity—rust-proofed, aluminum finish.
5. All diaphragms are lacquer treated to assure minimum moisture absorption.
6. Cone and spider assembly selected for maximum power handling and tone quality and minimum distortion and break-up.

There is a Utah Speaker for every original equipment or replacement requirement.

Write for catalog and complete information to UTAH RADIO PRODUCTS CO., 810 Orleans St., Chicago, Illinois. Canadian Sales Office, 560 King Street West, Toronto, Canada. Cable Address: Utaradio-Chicago.

THREE OF THE 90
DIFFERENT
MODELS OF UTAH
SPEAKERS



H-15-P

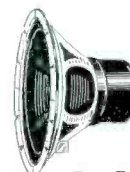

F-12-P

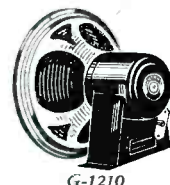

G-1210



S P E A K E R S

VIBRATORS • TRANSFORMERS • UTAH-CARTER PARTS

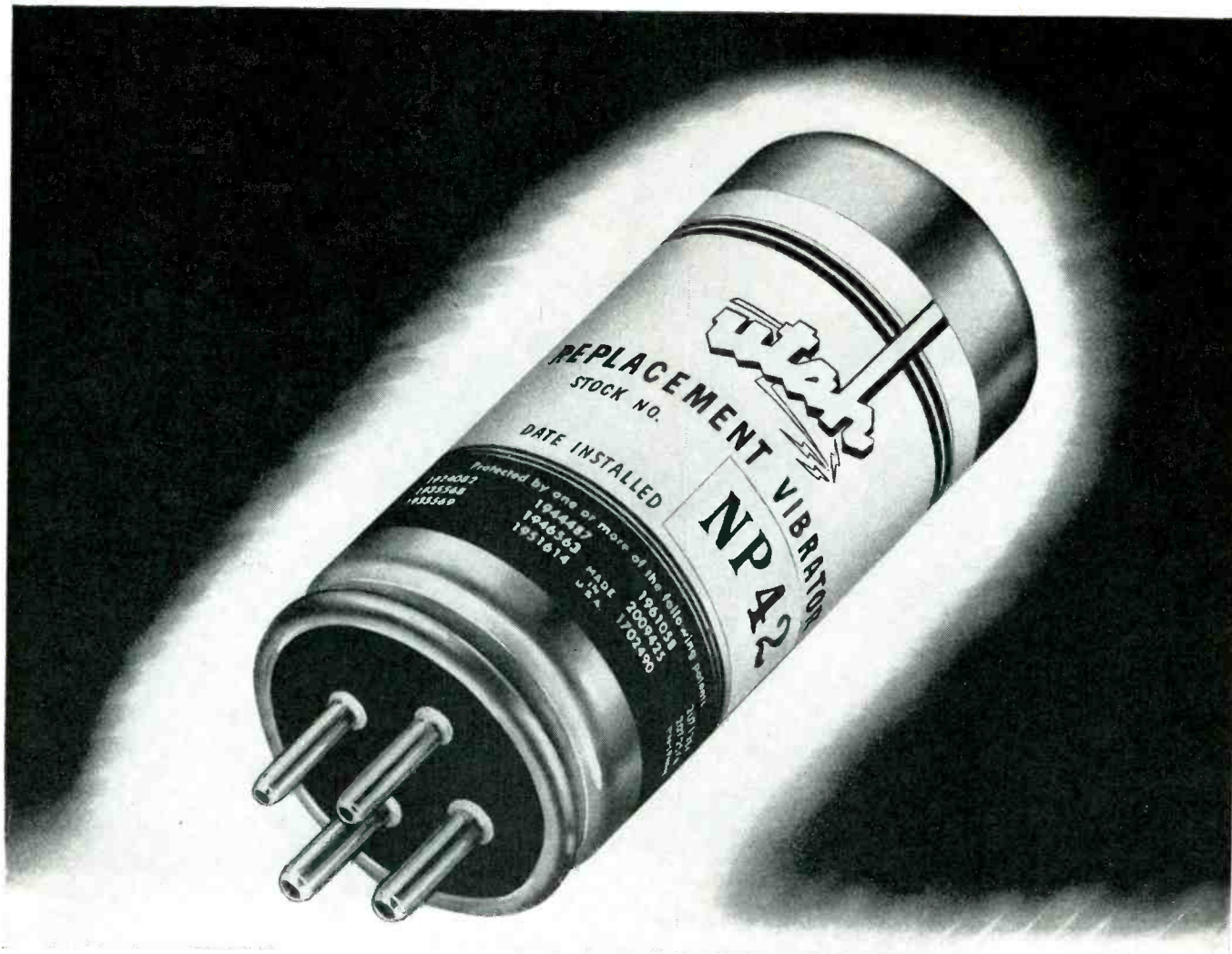

**I'M PROTECTING MY REPUTATION
AS WELL AS MY INCOME**
—by Using **UTAH VIBRATORS**

Dissatisfied customers can ruin your reputation faster than almost anything else. This danger can be avoided easily and surely by using Utah Vibrators. The Utah line provides exact replacements for every vibrator requirement.

Utah's rugged, time-proved construction assures absolute dependability. Only the finest materials available are used in their manufacture. They are "Life Tested" in Utah's laboratory—the industry's most versatile and best equipped.

And they carry a 12-month guarantee against defective workmanship and materials.

DON'T TAKE UNNECESSARY CHANCES
Write for your FREE copy of the new vibrator replacement bulletin. It's complete—contains all the information a competent serviceman needs for auto radio and battery-operated home receiver replacements—just tell us where to send your copy. There's no obligation. **UTAH RADIO PRODUCTS COMPANY**, 810 Orleans Street, Chicago, Illinois. Canadian Office: 560 King Street West, Toronto. Cable Address: Utraradio, Chicago.



V I B R A T O R S
SPEAKERS • TRANSFORMERS • UTAH-CARTER PARTS

**MILES FROM PORT
YET SAFETY AT ARMS LENGTH!**

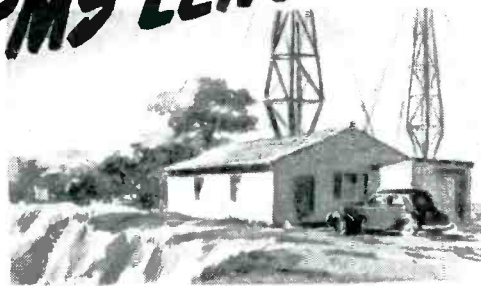

24-HOUR SHIP-TO-SHORE COMMUNICATIONS SERVICE PROVIDED BY GREAT LAKES COASTAL STATIONS WITH THE AID OF

**RAYTHEON
TUBES**

The new marine radiotelephones make it almost as easy for a boat owner to "call up" his home, office or the Coast Guard as though he were on land. He merely picks up a telephone handset and talks! Stations like the Lake Bluff Coastal Radio Station on the western shore of Lake Michigan and the Loraine Station on Lake Erie handle the traffic . . . "hooking up" the boat by a land wire to any telephone in the world!

With transmitters and receivers on the air 24 hours a day, the station equipment takes a beating. It isn't any wonder that RAYTHEONS carry the burden.

RAYTHEONS were chosen because tube efficiency and dependability is important. Yet they are just "stock" tubes, such as are used by thousands of servicemen for replacement work . . . servicemen who know that the way to be the biggest service organization in town is to insist on quality parts. Yet RAYTHEONS cost *no more!*

Your Raytheon Distributor has an unusual tube deal for you. See him without delay.

NEWTON, MASS. • NEW YORK • CHICAGO
• SAN FRANCISCO • ATLANTA

TRANS. MITTING
GLASS C-TYPE
L-60K 1B. BANTAM
C77 HEARING AID

RAYTHEON
MAKES THEM ALL

WORLD'S LARGEST EXCLUSIVE RADIO TUBE MANUFACTURERS

YOU'RE GETTING
Even Better
SYLVANIA TUBES
BECAUSE OF THIS
SYLVANIA BOMBARDER

THANKS to the extreme accuracy of this Sylvania designed and built "bombarder," the gases absorbed in the metal parts of a tube are completely eliminated from Sylvania Radio Tubes. And, note this, *without injuring the metal parts in any way!*

A high frequency induction "heat treatment" does the job while the tubes are being evacuated. Apply too little heat and gases remain to hinder proper tube operation. Too much heat and the metal is permanently injured! That is why Sylvania's skilled engineers design and build their own "bombardeers" that heat each metal part, never too much, never too little.

The result insures the *quality performance* of every Sylvania Radio Tube—a performance that makes satisfied customers for you!

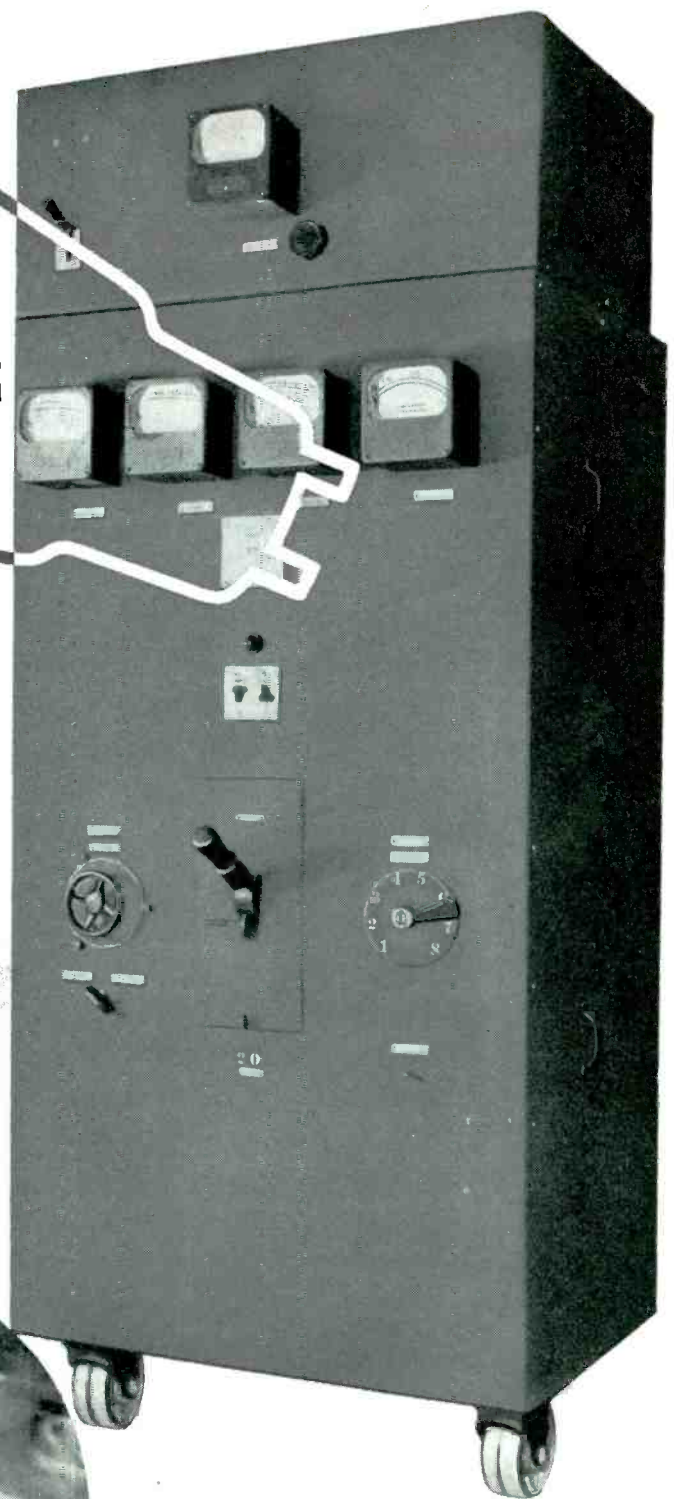
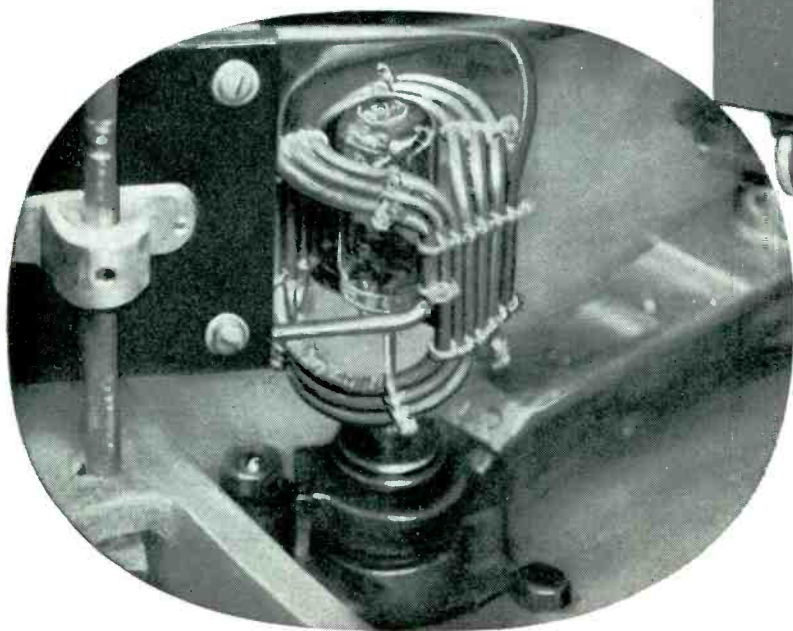

SYLVANIA

SET-TESTED RADIO TUBES

HYGRADE SYLVANIA CORPORATION, EMPORIUM, PA. • ALSO MAKERS OF HYGRADE LAMP BULBS

\$2.30 LIST*

For a
Jensen
REPLACEMENT
SPEAKER

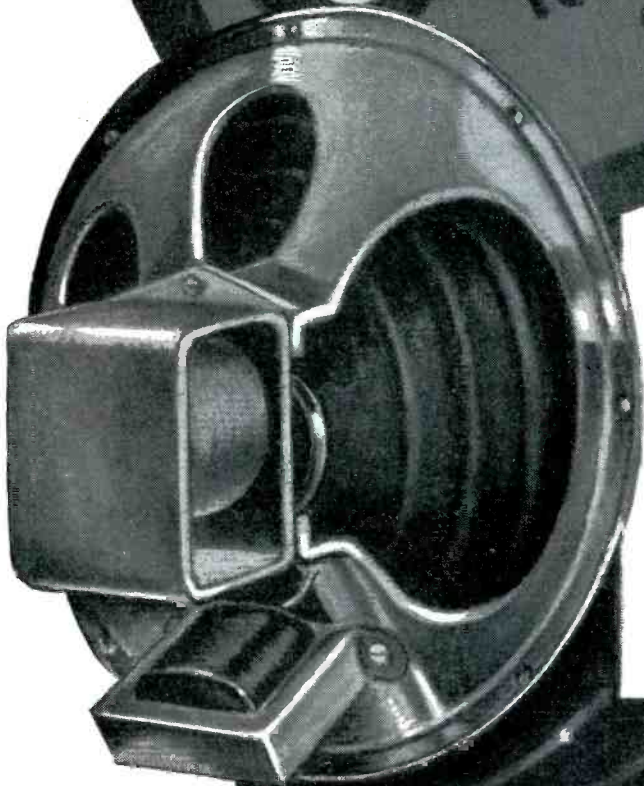

With a **JENSEN**
replacement speaker *you*
know you are giving your cus-
tomers the best there is.

Yet you can sell genuine **JENSEN**
replacements at prices so low
that *your customer pays no pre-*
mium for JENSEN quality. So
there really isn't any reason to
use anything but the best.

** Subject to your usual trade discounts.*

"RCA FRANCHISE

...solves the Profit Problem"

Says FRANK MAYER, PRESIDENT,
FRANK MAYER CO., CORPUS CHRISTI, TEXAS

"In my opinion, the RCA Franchise solves the profit problem for the man in this business in a very simple way. It offers a *complete* line of test equipment and amateur equipment, power tubes and receiving tubes. And then it tops things off with *quality* that assures customer satisfaction."



RCA AR-77 Receiver. Unmatched stability—unmatched signal-to-noise ratio! Polystyrene insulation. Variable selectivity. Adjustable noise-limiter . . . and every other feature that sells sets to hams!

YOU'LL travel a long way before you meet a man whose popularity measures up to Frank Mayer's—or one who knows the radio business as well!

He agrees with us that RCA Test Equipment, RCA Receiving Tubes, RCA Power Tubes, *plus* RCA Amateur Equipment, are the four cornerstones on which you can build a really *profitable* business.

Look at the RCA AR-77 Receiver illustrated, for instance . . . with every feature amateurs want—and pay for!

There's plenty in the RCA Franchise for you! Write for information.

Over 335 million RCA Radio Tubes have been purchased by radio users. In tubes, as in parts and test equipment, it pays to go RCA All the Way.

Now the RCA Franchise
is more valuable than ever!
AMATEUR EQUIPMENT
Added to Test Equipment—
Receiving Tubes and Power Tubes



Go RCA for the
"Full-Line"
Franchise!

- ★ Amateur Equipment
- ★ Test Equipment
- ★ Receiving Tubes
- ★ Power Tubes



Tubes and Test Equipment

RCA MANUFACTURING CO., INC., Camden, N. J. • A Service of Radio Corporation of America

AUDIO and VIDEO

SELL-UP PROPAGANDA has been rubbed into the trade's hair for several years in the face of declining radio prices and we'll admit without shame that we've done our share of the massaging. Until this season it seemed like shoveling sand against the tide but, just when the apparent hopelessness of the task tempts us to change the needle it becomes apparent that manufacturer pricing of midgets is actually going up at least one small notch. Not much, understand. But the first actual step in the right direction **BROADCAST FREQUENCY CHANGES** widely heralded as an Open Sesame into homes with pushbuttons to be reset around August 1 will probably not be made until after election if our Washington ear-to-the-ground is functioning with its usual accuracy **JOINT PROMOTION** by the NAB and the RMA, which we openly hoped for in a February paragraph, will continue this year. RMA's Board said it with cash at a meeting April 18, matched money voted earlier by broadcasters **LISTEN BEFORE YOU VOTE** campaign, part of the industry's cooperative effort, is daily gathering more support and the "National Radio Festival," to be celebrated June 3-8 by many stations, is receiving the active interest of the RSA **PLUG-IN PARTS** have hitherto been confined to such things as vibrators. Now plug-in transformers and filter condensers are beginning to make their appearance in sufficient number to arouse speculation concerning servicing of the future **FARM SETS** were one of the



BUSINESS AS USUAL—Selling radios ("Hear the Boys Sing") while simultaneously serving to further stiffen the civilian upper lip ("Munitions for the Home Front") is this stout advertisement by one of Britain's largest set makers. It excites no envy . . .

needs we spotlighted during our recent "Designing Dealer" article series and we pointed out that dealers wanted more consoles carrying a good unit price. Manufacturers have taken the trade at its word and are supplying such big sets for the rural market but report that while dealers may want them orders seem to indicate that the consumer is still being sold table types below \$50 **D-C HOMES** in the United States probably number no more than 1,000,000 chiefly in old sections of old cities, and no new homes at all have been wired for direct current in a number of years. Compare this figure with the number of radios designed to work on d-c as well as a-c and it becomes obvious, if it wasn't before, that the real reason is price **F-M SALES CYNICISM** on the part of some dealers is a curious

phenomenon. They say "static" is not troublesome and people won't pay for tone. This from men who have been bellyaching for years about the difficulty of selling mere radio "gadgets." Just exactly what do such retailers need in order to sell new radios? **TELE USERS** would naturally like more programs and better programs but checkup in the New York area once again indicates that they also like what they are at present getting sufficiently to be satisfied with their investment **PUSH-BUTTONS** avoid the last inconvenience possessed by radios, make it unnecessary to wait right at the set for tubes to warm up. If you haven't sold them from this angle you are missing a bet **PITY THE POLICE** in West Orange, New Jersey, radio cars. The other day headquarters was drowned out for more than two hours by a children's program emanating from a distant shortwave broadcast station that for some reason or other jumped frequency **GETTING PEOPLE IN** is the retailer's usual problem but there are times when it is desirable to get time-wasters out. Slickest method we've ever seen is to walk them out. You just keep talking, smiling, being polite, but take short steps toward the door. The victim unconsciously inches with you and usually eases himself into the great outdoors with the remark that he hates to leave so unceremoniously but has just remembered something important he forgot to do!

Mac
W. MacDonald
EDITOR

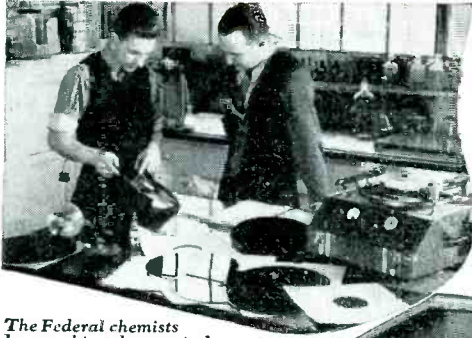

The Federal chemists have achieved an entirely new and exclusive formula for disk coating, absolutely non-inflammable, producing finest recordings with surface noise eliminated.

FEDERAL OPENS RECORDING DISK FACTORY

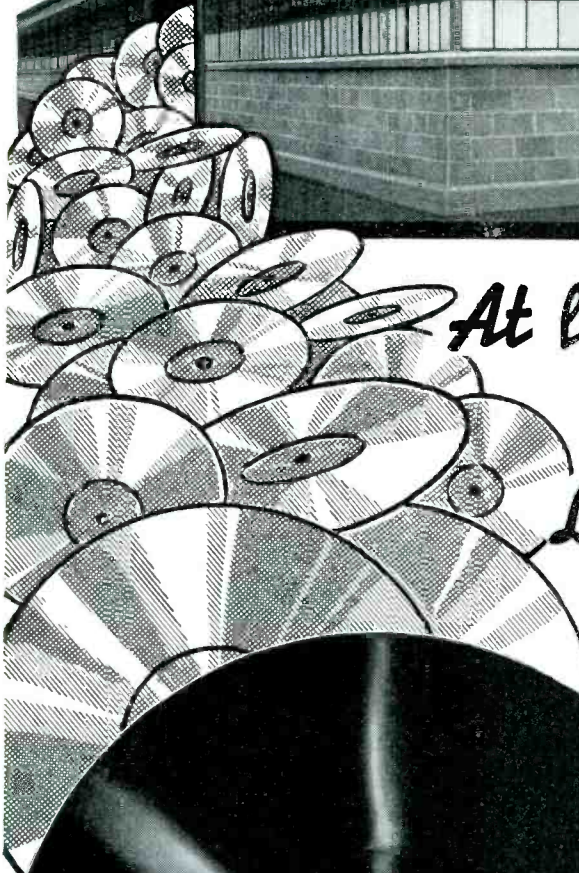
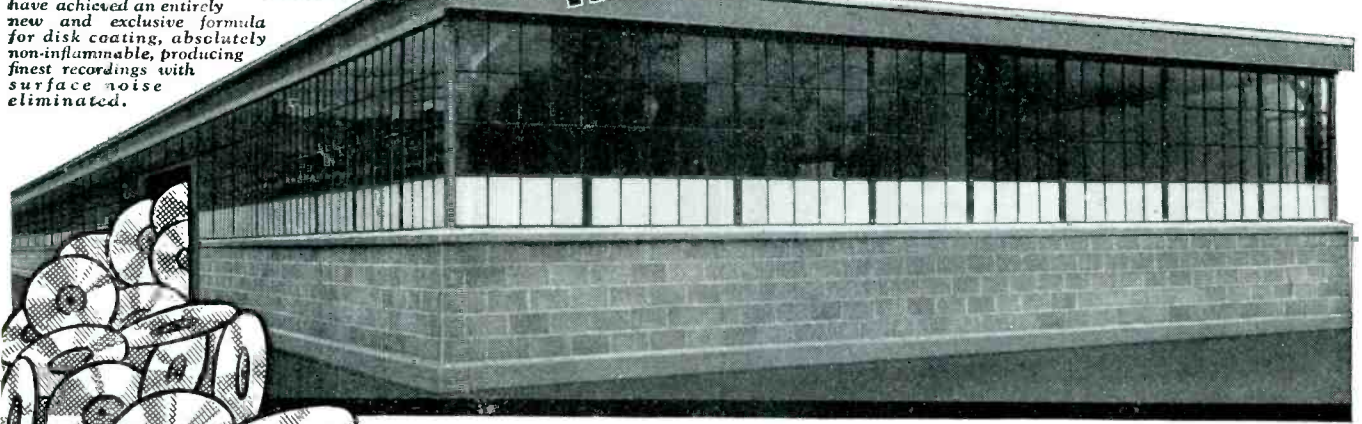

At last . . . a non-inflammable metal base Disk at the *Lowest Prices* ever offered

1. Non-Inflammable—Safe for Home
2. Heavy Metal Base—Non-warp, Non-slip
3. Hundreds of Playbacks
4. Half the price of other Professional Disks

Now at last, Federal chemists and research men have achieved an entirely new and exclusive formula for disk coating, absolutely non-inflammable (shavings will not burn), producing the finest and most faithful recordings, WITHOUT SURFACE NOISE. Metal base, heavily coated both sides,—a transcription disk at one-half competitive prices.

So important is this great achievement to the Recorder industry and so eagerly sought by Recorder users, that Federal is equipped to supply a national volume demand. The new modern Federal disk plant at Elkhart, Indiana, is the last word in scientific production facilities; year-round air conditioning throughout, assuring absolute uniformity of product; machinery and processing equipment of the very latest, improved type for mass production. This plant is now under operation. Centrally located, it will be the hub of Recorder disk distribution for the entire nation.

Write Us for the Name of Your Distributor or Mail or Wire Your Order Direct

FEDERAL RECORDER CO., INC.

50 West 57th Street Dept. 5210 New York, New York 101

RED LABEL Federal Disk
Sizes and Prices

- No. PN-6 1/2—6 1/2-inch . 20c each
(Package of 5 for \$1)
- No. PN-8—8-inch . . . 30c each
- No. PN-10—10-inch . . . 40c each
- No. PN-11—11-inch . . . 50c each
- No. PN-12—12-inch . . . 60c each
(Prices west of Rockies, slightly higher)

At the IVANHOE



UNIQUE UNION of 20th Century science and atmosphere of the Middle Ages is engagingly encountered at the "Ivanhoe," popular Chicago night-spot-in-a-stone-castle, where proprietor Ralph Jansen has hit upon an indoor variation of the "Man on the Street" program idea.

From table to table on a wheeled cart goes the pictured recorder, a resourceful and waggish interviewer asking patrons views on senseless questions. Played back later, comment is the hilarious highspot of the evening's entertainment.

Fortunate in the possession of a complete sound system over which to "broadcast" throughout its building is the club. Installed some time ago, it carries original music, radio flashes, mike announcements to distant rooms. Particularly useful is the system for transmitting recordings while the orchestra is off duty.

Tried on speculation and now a permanent feature of the establishment was the recording of full-length discs for interested customers, charged \$1 per throw for this extra service. Profitable sideline, the activity is also proving to be excellent advertising. Records cut in a soundproof studio carry messages invariably including a restaurant credit-line all over the country and even to foreign lands.

The Ivanhoe, if you like local color, is an outgrowth of its owner's boyhood hobby, study of Sir Walter Scott's fictional heroes.



Not So Medieval

Starting in a single store-front, the business soon swallowed up the better part of a city block with its six bars underground "Catacombs" and a slow-gear'd elevator which gives patrons the illusion of dropping hundreds of feet into the earth.

Featured in the club's decorative scheme is a virtually priceless collection of ancient weapons and armor, scattered throughout the "castle." Behind suits of armor, in fact, are the sound system's loudspeakers.



SOUND AT A CEREMONY

Concealed microphones on the altar and pulpit picked up the enthronement ceremonies of the Most Rev. Samuel A. Stritch, D.D., in Chicago's Cathedral of the Holy Name. The permanent sound system in the Cathedral carried the service within the building and for the thousands of persons unable to gain admittance, outside reproduction was provided for by specially installed RCA amplifying equipment

JUST SET AND RELAX

Find the housewife who couldn't use to good advantage a time control as incorporated on this Norge electric range. Setting this gadget at any pre-determined time the kitchen radio, for instance, can be automatically turned on to receive a favorite program and also with those tricky knobs, can act as a notifier when that frosty chocolate cake or roast is ready

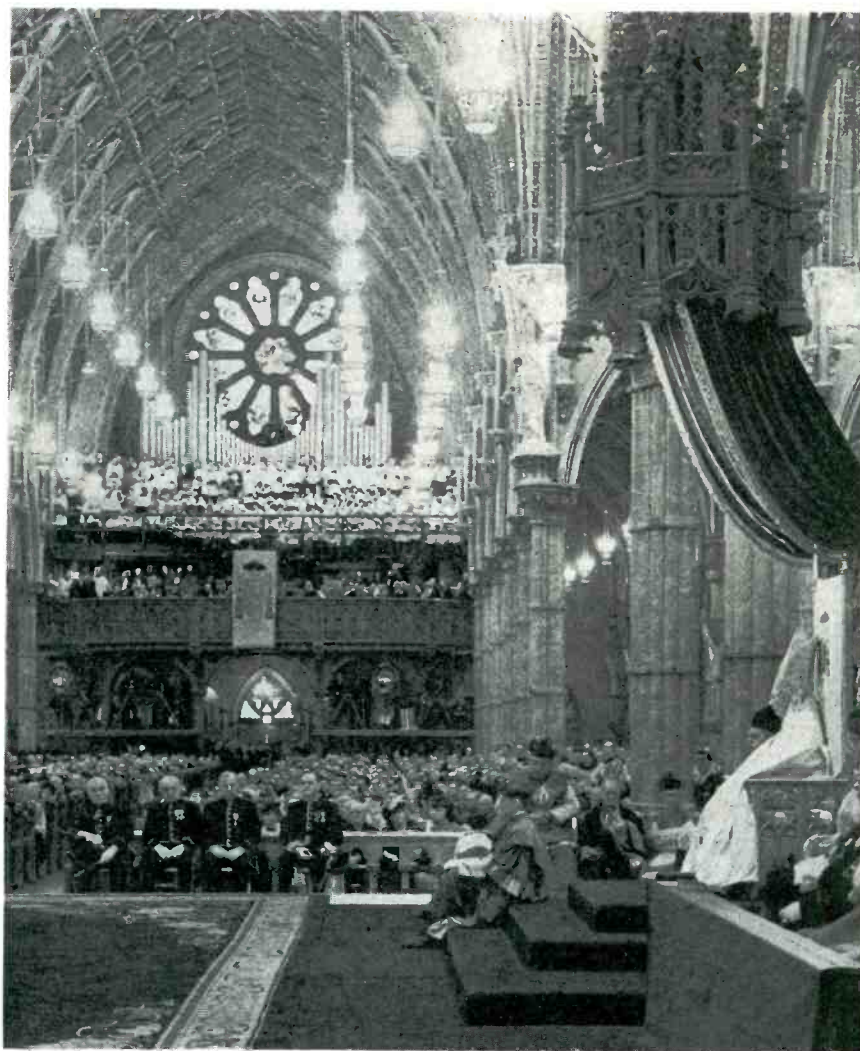

PHOTOShorts

Pictures from the News
to help you SELL

GOOD DEEDS GOOD WORK

Eagle Boy Scout's Troop No. 5 proudly display the activities of the troop, its course of study and work at Merit Badge Exposition, Cincinnati Union Terminal. The troop called upon The Crosley Corp., for radio equipment to help round out the exhibit

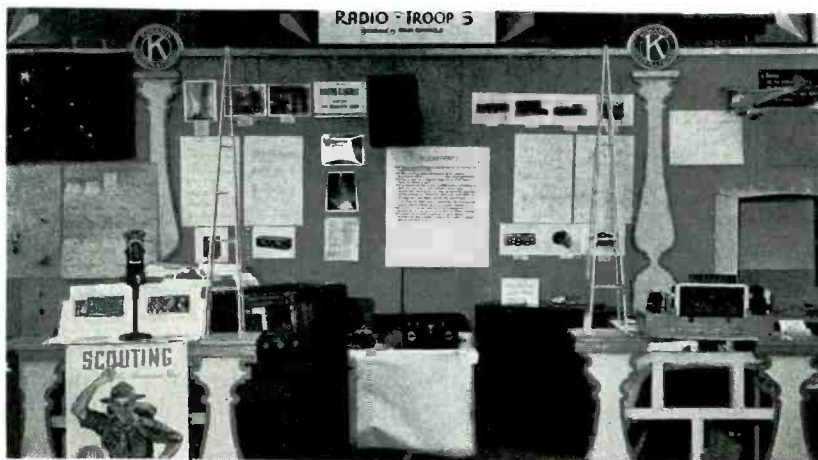

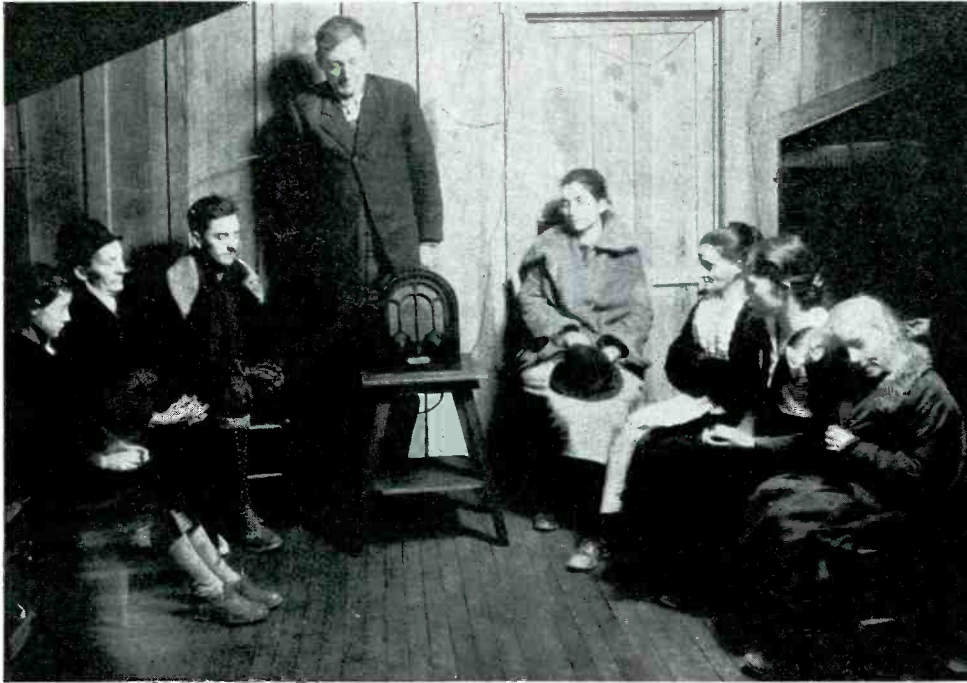

RADIO, MOUNTAIN FOLK'S PRIZED POSSESSION

Group of Kentucky mountaineers listening to news broadcast at radio listening center in hills of Martin county, Kentucky. Dissemination by radio found to be greatest single factor as an educational medium for people in the hills. It is their living newspaper

PHILCO DIST. FRONT AND CENTER

The execution and effectiveness of this refrigerator display gained the Broome Distributing Co., Syracuse, first award in nation-wide Philco competition. Basis for award was an enlargement in color of a recent magazine spread. Display arranged to cover the dealer's entire show window



ATTENTION! LESSONS IN SAFETY

The "Voice of Safety," San Antonio's new police sound truck with Policeman Dobbs testing and ready to start out on a cruise around the city. When he sees a minor violation he will pick up the "mike" and warn the driver of the offending vehicle. The accompanying photo shows Officer Dobbs about to reproduce a record on traffic safety

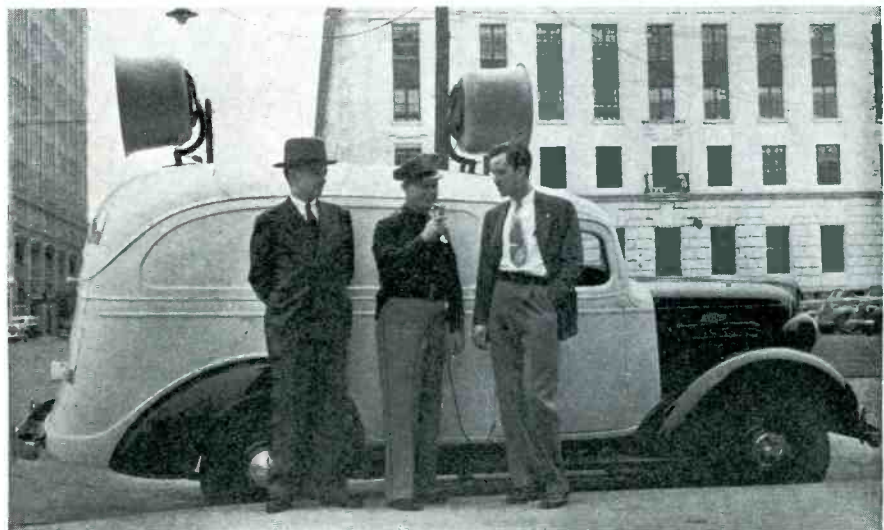

ABC OF FREQUENCY-MODULATION

HOW it differs from AMPLITUDE-MODULATION

F-M TRANSMITTERS work like a jitterbug jumping from side-to-side in time with music



A-M TRANSMITTERS work like a jitterbug jumping up-and-down in time with music

WHY it discriminates against OUTSIDE NOISE

F-M RECEIVERS provide plenty of room for side-to-side modulation movement but very little for up-and-down variation which is a natural characteristic of noise*



A-M RECEIVERS provide room for up-and-down modulation movement which is a necessary characteristic of conventional radio signals as well as a natural characteristic of noise

HOW HIGH-FIDELITY is aided

F-M HIGH NOTES merely require more speed in the signal's jumps from side-to-side but not more bandwidth †

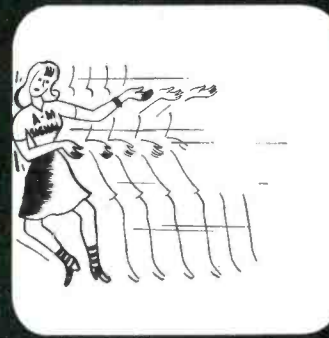

A-M HIGH NOTES involve jumping of the signal to greater widths and so require more airspace than low notes

WHY DISTANCE COVERED is short

F-M STATIONS are being assigned operating channels on the ultra-high-frequencies (extremely short waves) and limited range is due solely to characteristics of these frequencies rather than to any peculiarity of the system itself ‡

* Both systems are subject to internal receiver noise where received signal strength is inadequate but F-M requires less signal strength

† Bandwidth determines F-M's ability to accurately reproduce volume peaks but because there is

room on the ultra-high-frequencies sufficient width is being provided for the new service. Bandwidth at present preventing transmission of all high notes the ear can hear by A-M stations in the broadcast band cannot readily be in-

creased due to existing crowding in this part of the radio spectrum

‡ Channel assignments on the ultra-high-frequencies are similarly responsible for television's comparatively short range

F-M NEWS

follow-up

FCC DECISION still awaited. Rumored trying to avoid transfer of tele channel. Now has 120 station applications on file. Armstrong hints 6 new licensees ready to climb aboard bandwagon

By W. MacDONALD*

EXPECTED MOMENTARILY is an FCC decision on Frequency - Modulation. Awaited since filing of briefs last month, this decision is important because it will not only determine F-M's "living space" and power in the radio spectrum but will probably legalize limited program support by advertisers at the same time.

Rumor from Washington has it that the Commission is trying to find a way by which F-M may be given additional channels without disturbing the #1 tele assignment. One argument of F-M men is that television receivers are already so complicated that construction and alignment for higher frequencies would not seriously up production cost where the necessity for satisfactory operation at such frequencies might add appreciably to F-M's necessarily lower list.

Still another complication probably delaying decision is the necessity for initially licensing stations in a manner which will avoid later geographical difficulties. We understand that the Commission now has approximately 120 license applicants to consider as compared with 39 in January and 80 in March. Plans suggesting the points throughout the country at which F-M stations should be spotted, reported filed by broadcasters, apparently cover only New England and the Central States and this leaves the problem of allocation in the rest of the nation entirely to the FCC for solution.

Simultaneously, it is becoming obvious that the Commission must also consider the probable use of Frequency-Modulation by services other than broadcasting. Chicago police witnessed a demonstration

late in April, a New York City police demonstration is scheduled, Long Island's Nassau County police and brassbutton men at other scattered points are exhibiting interest.

On Manufacturing Front

On the manufacturer's front most interesting news this month was picked up directly from Major Armstrong, who told us that six new licensees would shortly be added to lists already publicized.

Radio Retailing, in March, stated that Stromberg-Carlson, General Electric, Stewart-Warner, Zenith, Pilot and Scott among broadcast receiver makers were known to have licenses, that producers of amateur and commercial gear such as Hallicrafter, National, Hammarlund and Radio Engineering Laboratories were aboard the Armstrong bandwagon and that both Meissner and Browning were advertising kits. Stromberg-Carlson has since inaugurated an extensive consumer magazine campaign, General Electric's D. W. May exhibited a new line including straight F-M table models, combination F-M and A-M consoles and a frequency-modulated wireless record player in Long Island City late in April, Hallicrafter started selling a combination F-M and A-M amateur receiver just after we went to press last month and from Zenith's distributor convention April 29 came a telegram stating that this company would have F-M models as soon as the FCC reached a decision.

Simultaneous checkup in factories other than those referred to above indicates that while few care to commit themselves prior to their national conventions most will have F-M merchandise ready for announcement from platforms along

with new A-M receivers if events between now and then appear to justify the move.

Among dealers in areas already experimentally served it appears that the almost simultaneous headlining of two potentially important new services such as television and frequency-modulation has robbed the latter of some of its initial interest.

F-M sales are proceeding on an orderly basis but it is noted that most sets moved so far have gone to (a) technical radio fans practically a "push-over" for almost any novelty equipment in this field and (b) classical music lovers who are almost fanatics on the subject of high-fidelity and freedom from extraneous noise. This business is better than nothing and one way to crack a market but important volume business will depend upon the dealer's ability to sell F-M as an auxiliary service to the average man-in-the-street and, particularly, the dealer's ability to up average unit sales by offering F-M and A-M in combination.

Among Metropolitan Dealers

Curious if it were not for the knowledge that television has dazzled the urban eye is the frequently heard metropolitan dealer opinion that few people suffer much from noise anyway and that the average listener wouldn't recognize high-fidelity if he heard it. For people have been crying for "static eliminators" for years. And criticism of radio tone quality has been growing. Even so, it should be realized by the trade that F-M will have to be *sold* and that cynicism won't do it.

ADVANCE SERVICE DATA

Read

Servicing F-M Receivers

By Dana Griffin

Elsewhere in this issue

* Editor



PORTABLES

Head for the Summer Spots

By TRAILER—

and

'PLANE



PICK-ME-UP, Playmate, and Carryabout are a few of the catchy names for popular portable radios which have taken the public's fancy by storm. The ever increasing sales of such sets has literally amazed the entire industry.

With the advent of 1.4 volt low-drain tubes, loop antennas, and small-size "A" and "B" batteries, modern portables were timidly introduced to the public in the fall of 1938. Not two years old, these fast-selling straight battery sets and combination battery-electric, 3-in-1 radios, were responsible for virtual elimination of the 1939 summer slump.

It is not hard to recall last season when peak sales were being made, the not uncommon sight of the vacationer, sportsman and tourist with a companion receiver, holding possessive importance in the traveling kit. These small sets popped out on the highways, train lines and waterways, turning out enjoyable music and entertainment.

Who couldn't use one of these receivers? It has plenty of personal appeal and provides a perfect gift for the family, friend, and makes an ideal business gift. For the birthday, anniversary or what-have-you occasion it has universal acceptance because of its usefulness.

**Assistant Editor*

In order to cash in on the 1940 summer peak sales of portables, start now to plan your campaign,

Six Ways to Push

There are numerous ways to direct your promotional activities in order to obtain a share of this business. Portables are riding the crest of the wave and even a hit or miss schedule will bring you in the right kind of "green paper." But why work on a hit or miss plan? Effort directed in the right channels will pay dividends.

Interviews with a number of dealers and department store radio managers reveal the following interesting facts regarding sales and successful promotional work on portable receivers.

-1- Window displays, now opportune, were found to be especially productive plugging portables. A good looking display need not be expensive to get its story across. A suitable backdrop, artificial grass,

one or two of the new airplane cloth bags, some golf clubs or tennis rackets for human interest and the set in the center will furnish you the best customer lure yet devised. Consult your jobber. He is your best bet for aid on displays. He should be in a position to help out on the necessary props, and supply promotional material.

-2- Plan your campaign with circulars, newspaper advertising, radio plugs and letters. If you must use a form letter, run it in offset printing. This latter type of letter is not comparable to personally typed correspondence but it is cheap and does have good appearance and with a personal signature it will bring in the inquiries. You have heard the following a number of times but it can stand repeating. Make your letter short, long letters definitely glide to the waste paper basket. Invite your prospect to preview the new sets, just the thing for his vacation, for the broker's office to

By CARL DORF*

GET STARTED NOW with promotion to
make sure of your share of this business



By BOAT—

and

TRAIN



lighter, use new power tubes and employ larger permanent dynamic speakers. There are 6 and 7 tube models with 3 tuning bands for reception on the regular broadcast band, short-wave range to 16 meters and the aviation and weather channels to 2000 meters. Marine models can be had for both ship-to-shore, coastguard and marine signals in addition to the broadcast band. There are tri-power portables for regular reception plus a phone jack for use by pilots on aircraft bands.

And Now "Candids"

"Candid" models have also been announced with the new miniature tubes. This type set weighs around 4½ pounds and measures approximately 8by5by4 inches. The majority of 1941 models are 3-in-1 sets, battery and a.c.-d.c. line operated. Some units are made with detachable loop antennas for better performance, on-off indicators and headphone connections.

The field for portable radios is as broad as it is long, another way
(Continued on page 57)

tune in the latest fireside chat, to hear the war news.

-3- Arrange your counter or rack display of the various models with neatness in mind. Set them off with bright colors. Dealer aids are important and helpful. A display card with appropriate sketches of portable radio applications will lend effective aid to sales. Stress the fact that there are many models available with a large variety of cases and improvements to suit the pocketbook.

-4- Augment promotion with convincing outside canvassing. Arm salesman with the best looking model in stock, plenty of folders and first hand information as to prices and features on the complete line. In this phase don't lean too heavily on order taking, leave the folder and invite the prospect to the store for personal inspection of the various models.

-5- Familiarize salesmen with the advancements incorporated in the

1941 sets. There are a number of selling points, which spotlight the new receivers. Don't push the selling of these personal sets over to the counterman or wrapper. They are small and unit price is not great but their gross sales can be large, with appreciable profit all the way down the line.

-6- Know your product. Many of the new models are narrower and

TUBES FOR NEW "CANDIDS"



MINIATURES
—Converter, rf-if pentode, diode-pentode and output pentode. They all have 1.4 volt filaments, work efficiently on 45 volts of "B"

FIGURES *Can FOOL You*

MODERN MANAGEMENT METHODS require intelligent interpretation as well as development of facts about your business. Here's how to put figures to work

By

M. D. GLEASON, C.P.A.*

EXHIBIT 'A'				
Store #	Net Sales Feb. 1940	Percentage of Increase Over Same Month Last Year	Gross Profit Rate Based on Net Sales Feb. 1940	Increase in Rate Over Same Month Last Year
21	\$7,370.	91%	29.6%	*
39	8,450.	65%	*	*
9	6,609.	51%	36.3%	3.2%
25	7,878.	50%	*	*
5	3,724.	48%	29.8%	- 6.9%
15	2,292.	34%	30.3%	- 12.1%
17	5,529.	21%	44.5%	2.0%
14	3,333.	7%	37.6%	9.7%
16	1,460.	*	28.5%	*
26	5,344.	- 4%	34.8%	0%
40	7,545.	- 6%	*	*
3	4,539.	- 13%	27.4%	*
7	3,653.	- 16%	33.8%	- 9%
8	1,428.	- 30%	37.5%	2.3%
Average per Store	\$4,950.	21%	34.0%	- 0.5%

* Not Available
- Represents Decrease

instead of only 21%, would be.....		\$6,765.
Your Gross Profit rate is... 44.5%		
Your Gross Profit rate if reduced by 6.9% below that of 1939, instead of the increased 2.0%, would be.....		35.6%
Gross Profit Earned is.....	\$2,460.	
Gross Profit Earned under the proposed basis would be.....		2,408.
Decrease in Gross Profit Earned under the pro- posed basis would be....		\$52.

Thus you see that, despite the \$1,236 additional sales, your Gross Profit would have been reduced by \$52 and Net Profit still further reduced by the expenses involved in getting the added business.

Profit Vs. Volume

You now ask, quite naturally, "what then can I do to increase my Gross Profit?" In order to answer this question, it is necessary to analyze the charts submitted below.

The following summary table shows how the total business of these fourteen stores was apportioned, by departments:

Department	Sales	Proportion of Total Sales	Gross Profit Percentages
Radio.....	\$19,554.	28%	39.7
Refrigerator.....	16,959.	25%	21.9
Other Major Departments.....	19,757.	29%	39.8
Minor Departments	12,884.	18%	34.5
Totals.....	\$69,154	100%	34.5

You will see at a glance that the refrigerator department is least profitable in these particular stores. Yet, it represents one-quarter of the total sales volume.

Obviously a decrease in sales of refrigerators which have a low gross profit percentage and a corresponding increase in sales of other major items which have a higher gross profit percentage would not change the total sales volume, but it would increase the gross profits earned.

DEVELOPING MONTHLY FIGURES about your business is one thing and interpreting them so that profit rather than mere volume may be increased is quite another.

It happens to be difficult, to begin with, if you don't have figures on other operations similar to your own for comparison. And such figures are not too readily obtainable in the radio business. This scarcity of figures for comparison is, in fact, one of the reasons for this and probable future articles.

Exhibit "A," appearing on this page shows sales and gross profits of a number of actual stores during the month of February. Let's see how these figures can help us to interpret our own. . . .

Figures For Comparison

Assume Store #17 is your store. You will note that during February, 1940, your sales increased

* Sirota, Kraus & Gleason.

21% over the same month last year, which is equal to the average increase of the group as a whole shown on the last line of the tabulation.

However, you cast envious eyes at Store #5, which was able to increase its sales 48%.

Apparently this store has done a good job. But does it necessarily follow that increased volume means increased profits?

Let us compare facts and see.

Your Store, #17, was able to obtain an increase in Gross Profit rate of 2.0% this February, compared with February, 1939, whereas Store #5, in its anxiety to build sales volume, suffered a decrease in Gross Profit rate of 6.9%.

Was the increase in volume worthwhile? Let's reduce these percentages to dollars and cents and see:

Your Feb. 1940 sales volume is.....	Actual	Proposed
Your Feb. 1940 sales volume if increased 48% over 1939,	\$5,529.	

EXHIBIT 'B'

RADIO				REFRIGERATOR			
Store #	Sales	Gross Profit %	% of Store's Total Sales	Store #	Sales	Gross Profit %	% of Store's Total Sales
40	\$2,550.	42.1	34	39	\$3,533.	**	42
39	2,430.	42.3	29	21	2,581.	23.6	35
7	2,134.	34.8	58	3	2,059.	22.1	45
9	2,028.	38.7	31	25	1,799.	**	23
25	1,704.	41.9	22	40	1,463.	**	19
21	1,632.	36.2	22	5	1,300.	20.9	35
17	1,423.	43.1	25	26	1,113.	17.9	21
26	1,321.	43.9	25	14	913.	27.5	27
5	1,080.	41.6	29	9	734.	11.8	11
15	1,040.	33.6	45	15	644.	22.4	28
8	799.	43.4	56	17	432.	34.5	8
14	620.	37.1	19	7	281.	32.0	8
16	569.	29.7	39	16	107.	14.9	7
3	224.	39.0	5	8	None*	None*	None
Average per Store	\$1,396.	39.1		Average per Store	\$1,305.	22.8	

OTHER MAJOR DEPARTMENTS				MINOR DEPARTMENTS			
Store #	Sales	Gross Profit %	% of Store's Total Sales	Store #	Sales	Gross Profit %	% of Store's Total Sales
25	\$3,718.	42.9	47	39	\$1,712.	34.4	20
9	2,756.	43.5	42	40	1,215.	33.1	16
17	2,318.	46.1	42	17	1,356.	46.5	25
40	2,317.	42.7	31	21	1,393.	34.9	19
3	1,986.	27.7	44	25	657.	34.2	8
21	1,764.	28.3	24	5	1,344.	29.0	36
26	1,690.	40.2	32	7	702.	30.7	19
14	1,523.	43.8	45	15	608.	32.2	26
39	775.	43.1	9	26	1,220.	33.0	23
7	536.	34.5	15	3	270.	55.7	6
16	374.	23.3	26	8	629.	30.1	44
5	None*	None*	None	14	277.	37.9	8
8	None	None	None	9	1,091.	29.8	16
15	None	None	None	16	410.	35.1	28
Average per Store	\$1,796.	37.8		Average per Store	\$ 920.	35.4	

* Stores that do not carry lines shown above were not counted in computing averages.
 ** Not Available.

You might, then, ask why we do not carry this thought to its logical conclusion and eliminate the refrigerator department altogether.

Such an extreme policy is not wise. Emphasis upon each department should vary to such an extent that the greatest net profits are produced thereby. Refrigerators may move easily when other departments are falling off in volume. But most certainly sales in other departments should be stressed during seasons wherein refrigeration sales are low.

Departmental Analysis

Exhibit "B" presents a detailed breakdown of the business of these same stores according to departments. To illustrate why your Store, #17, is more successful than

Store #5, in terms of Gross Profit rate, consider the following comparison—taken from Exhibit "B":

Department	STORE #17		STORE #5	
	Gross Profit %	Store's Total Sales	Gross Profit %	Store's Total Sales
Radio	43.1	25%	41.6	29%
Refrigerator	34.5	8%	20.9	35%
Other Major Departments	46.1	42%	None	None
Minor Departments	46.5	25%	29.0	36%
Total	44.5	100%	29.8	100%

Thus we see that Store #17 gets its greatest volume in the department of highest gross profits, whereas Store #5 gets its least volume from the most profitable department.

Unlike Store #5, Store #17 pushes least the refrigerator department, which has the smallest Gross Profit rate.

Similarly, we might compare Stores #9 and #3:

Department	STORE #9		STORE #3	
	Gross Profit %	Store's Total Sales	Gross Profit %	Store's Total Sales
Radio	28.7	31%	39.0	5%
Refrigerator	11.8	11%	22.1	45%
Other Major Departments	43.5	42%	27.7	44%
Minor Departments	29.8	16%	55.7	6%
Total	36.3	100%	27.4	100%

Here too, it may be seen that

(Continued on page 58)

More about BUILT-IN

By

S. GORDON TAYLOR*

LAST MONTH in the article "Built-in Radio Profits" the potentially tremendous and rapidly growing market for built-in home installations, with their larger dealer unit sales and worthwhile installation charges, was discussed in some detail. This month we turn to matters of equipment and installation, and present two types of layouts suggestive of the infinite variety with which built-in installations can be planned.

Wiring Before Wallpaper

The combination drawing and photographs show rather complete details of Lafayette radio and communications equipment incorporated in the plans of a small house recently designed by Walter Prokosch, New York architect.

With most of the equipment actually built into the walls, as in this case, planning should be done before the interior construction starts, so that the necessary mounting holes can be provided and properly framed by the carpenters and wiring concealed within the walls.

The radio system includes a modern 11-tube chassis and speaker mounted in the living room wall and extending through so that the rear of the equipment is accessible from the basement stairway inclosure behind this wall. In addition, extension speakers (with individual local volume controls, and substitute load pads to avoid overall volume variation when any speaker is cut in or out) are mounted in the wall between one bedroom and an adjoining closet, and on the surface of the recreation room wall.

This arrangement makes broadcast entertainment available in three

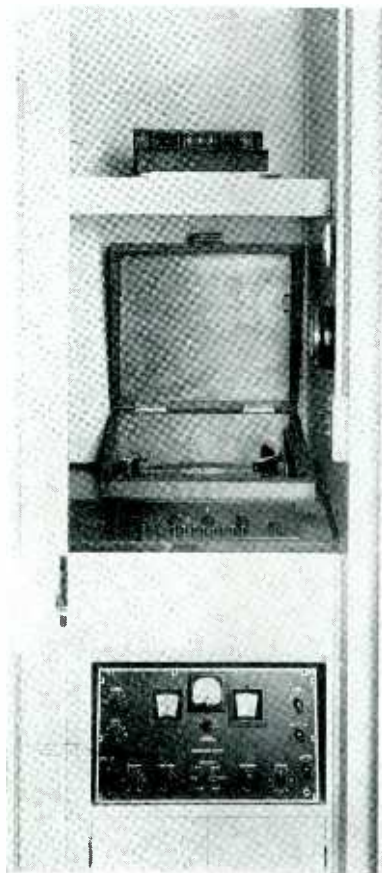

Old HOME Installation

Installed within a closet, setup includes (from top to bottom) record album storage, automatic record-player, broadcast tuner and shortwave receiver. Concealed in the closed half of the closet is a high-fidelity audio amplifier and a four-speaker "woofer-tweeter" system.

important rooms. In addition, a second outlet of the built-in, multiple antenna system is located in the nursery where a separate radio set enables the children to tune in their own favorite programs.

Why Stop with One?

The intercommunication equipment consists of two separate systems, each with one master station and of a type which permits 2-way communication between master and remote stations, but does not involve the manipulation of push-to-talk switches at the remote stations. The upstairs system connects the nursery to the mother's room, and is in

HOW TO PLAN for intercommunicators

effect used as a call system, so that any sounds in the nursery during the night will be clearly audible in the other room.

The second system is for the primary purpose of enabling the lady of the house or the maid to converse with persons ringing either the front or rear door bells, avoiding the necessity for opening the doors to strangers. It is at once a step-saver and a safeguard. In addition to this service, a remote station is also located in the basement recreation room. Except when the master station upstairs is in actual communication with the door stations, its selector switch is set for the basement remote, so that either station can call the other or be called, thus saving many trips up and down stairs.

Write Your Own Ticket

A quite different type of built-in radio is an installation made by Nathaniel Bishop, consulting and design engineer of Fairfield, Conn., and specialist in built-in installations.

As shown in the separate photo, the installation is built into a closet. Included is a high-fidelity broadcast tuner horizontally mounted with its push-button control panel on the sloping table surface in front of the automatic record player equipment. Beneath this, mounted in the face of the inner cabinet, is a communications type receiver used for short-wave reception. Both these units (and the phono) work into a separate, high-fidelity audio system which feeds a 4-speaker woofer-tweeter combination mounted in an infinite baffle arrangement in the other half of the closet (concealed by the closed door in the above illustration).

* Feature Contributor.

Profits

master control radio wiring,
and separate personal sets

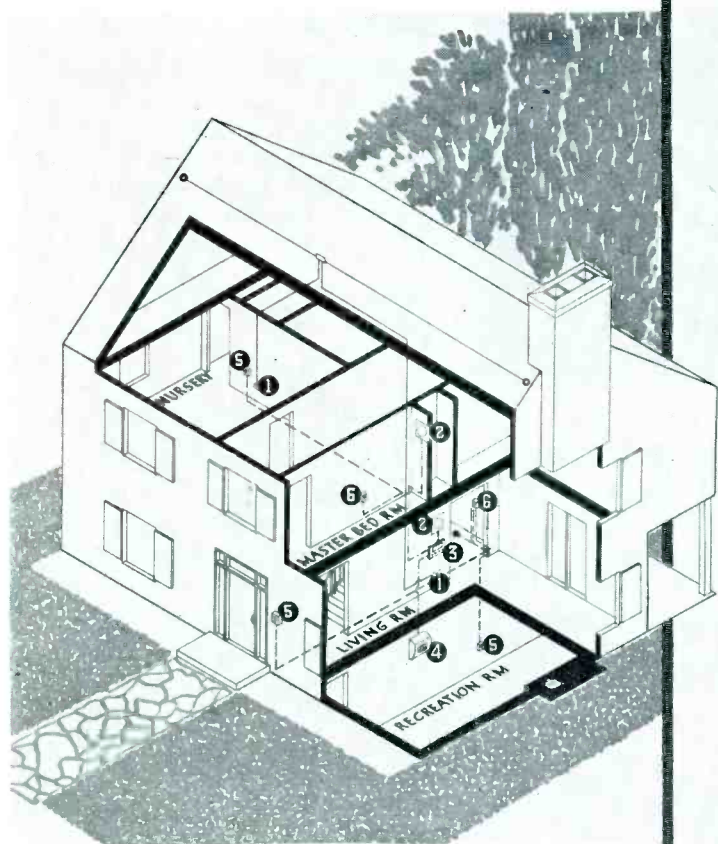

New HOME Installation

1. Antenna outlets
2. Speakers in walls
3. Radio Tuner
4. Speaker on wall
5. Remote Intercommunicator
6. Master Intercommunicator

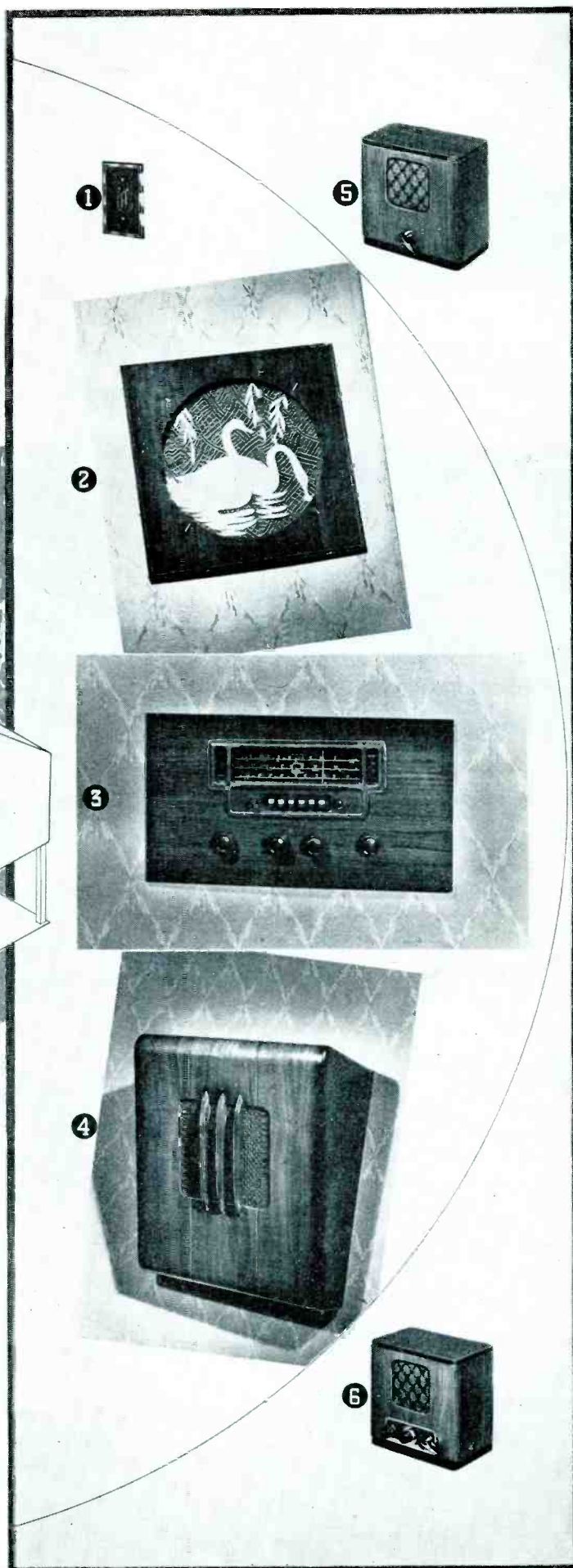

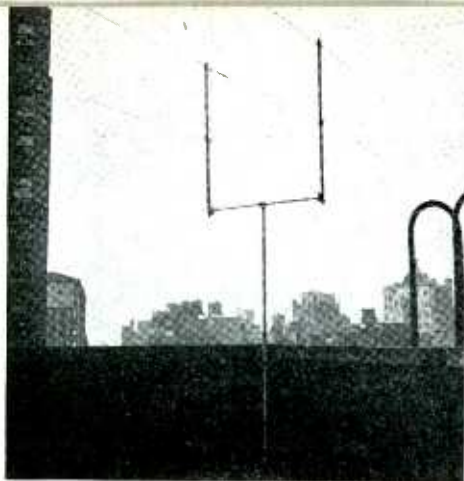

STORE SKYWIRES — Typical installation by Mac-Adams for ABERCROMBIE & FITCH (above), and STERN and GIMBEL BROTHERS (below)

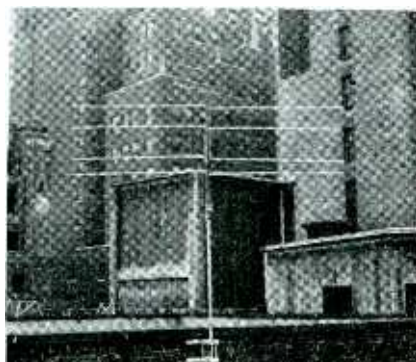

TELE *Sales* TIPS

TODAY OR TOMORROW, depending upon location, other factors dictating modest or major merchandising effort, these tested suggestions will come in handy

IT IS NEVER TOO EARLY to study merchandising methods tried by others. Eventually you may wish to adopt them, with or without modification to suit your own particular needs.

Television merchandising ideas are no exception. They are, however, relatively rare because of the newness of this business and its confinement so far to just a few areas.

One possible source of information, it occurred to the Editors, would be the man most closely in contact with dealers in the New York State area bounded by Kingston, Paulding, Port Jervis-Monticello and Haverstraw during RCA's October 7-December 1 merchandising test. Investigation disclosed that this man was *Forrest Crain*.

We interviewed Crain, asked him a series of questions relative to tele-

vision merchandising most frequently propounded by readers.

Here are our questions, and his answers:

Q: *In your opinion, will television receivers be most readily sold "off the floor" or in the home?*

A: Maintenance of a store display and demonstration is essential as most leads will originate there

forming such an outside sales organization on a modest scale and expanding it when results justify the expansion. The dollar volume involved in connection with major items of merchandise such as televisions will often make this practicable where the dealer has not seen sufficient margin in the products he has handled heretofore to justify outside selling effort.

Supplements Store Demonstration

Q: *What kind of a store demonstration setup would you recommend to the average dealer?*

A: I would recommend that a separate room be used for television, if possible. A corner of the store, screened off in some manner, is the very least I would suggest as privacy for salesman and prospect is just as essential for good results as it is in, for example, the record business. Where possible, I would also recommend that a homelike background and other furnishings be used as a television is inclined to look large and bulky when displayed along with radios while this impression is minimized by proper surroundings. Seating for about 15 people is desirable. So are lights that may be dimmed without affecting the rest of the store.

Q: *Would you recommend a similar setup for larger, departmentalized stores?*

A: Yes, I would. Televisions might, however, also be installed in lounges, near the main entrance and at other points to bring traffic to the main department for actual demonstration and sales work, with good effect.

Initial Promotion Ideas

Q: *What forms of promotion would you recommend to the average dealer when he starts out after a television toe-hold?*

A: There are many possible promotional methods. I'll briefly mention a few that seem most effective to me. Send out special invitations to attend a store demonstration to well-known local people, by letter, 'phone or by personal messenger rather than through generalized advertising. Approach businesses having liquor licenses with a direct

(Continued on page 58)

but outside selling is desirable as actual closing will generally take place in the prospect's home. Many additional prospects will also be unearthed by outside salesmen, who will frequently invite people to see their first televised program at the store and then arrange further demonstration in the home only after a sale seems virtually certain.

Q: *Does this mean retail organizations already possessing an outside selling organization have the "edge" on others selling primarily from the floor?*

A: Yes, it does, for as with any new product more is necessary for successful merchandising than the mere setting up of a stock, store demonstration and general advertising. There is, however, nothing to prevent floor-selling organizations

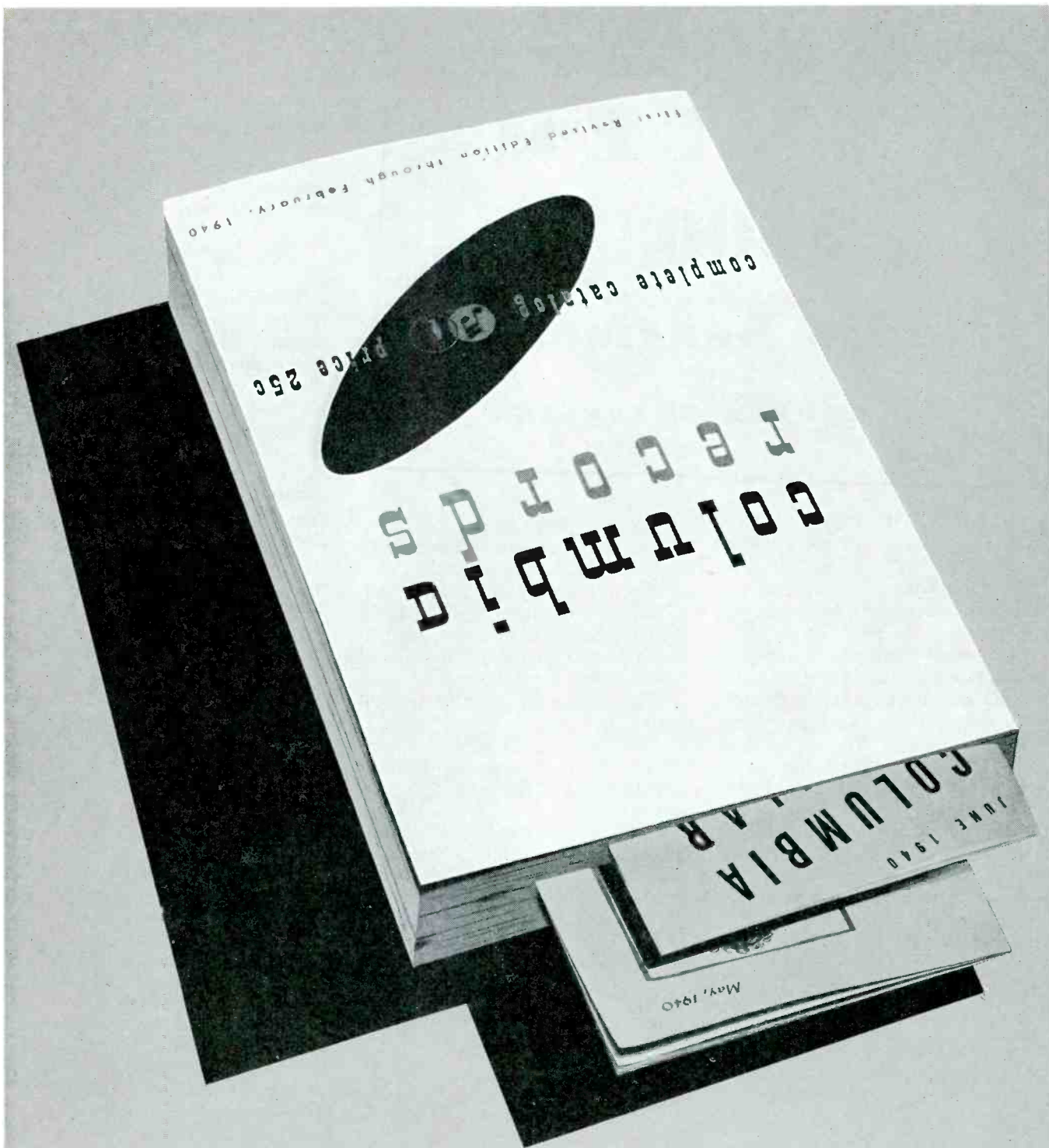

A man is known . . .

Look through the new Columbia Catalog (it's just been issued) and you'll see why it's the greatest success story we can tell of the artists on Columbia Records. It's the big reason why we suggest...this year, Climb with Columbia!

WANTED

2500

Radio Servicemen

By HAROLD F. JENKINS*

IF AN ADVERTISEMENT reading like the above appeared in the want ad columns of any metropolitan paper it would in all probability create an avalanche of applications.

Servicemen answering such an ad would most likely include those who are finding competition and cut-price city methods too keen to be enjoyable. Others, who realize that their particular location is top heavy with service shops and those, looking for a location where "let live" repair charges are obtainable with a substantial amount of year-around work.

This number and many more service shop placements, with answers to the above types of applicants wishes, are open in small communities and rural districts.

Worth Investigating

It has been demonstrated that the small town with rural trade areas, will provide servicing requirements to profitably support a good service shop. There are numerous centers without direct service competition, which would prove ideal locations for a competent serviceman. Store rental as well as expenses for living quarters in the small town would be very low in comparison to what the city man sets aside for this part of the overhead. Yet, the service charge can be higher for the local repair job. Here again is the competitive angle, not so keen as in the large cities.

The writer has for many years been connected with a radio parts distributor who to a large extent

* Fred C. Harrison Co.

serves small town radio stores and repair shops. Calling on these small communities, a real necessity was indicated in many ways for good technical servicemen. In fact, I have been instrumental in spotting such localities and in placing men in a dozen or so profitable locations.

Who took care of this service before the shops were located? Didn't this work go to nearby larger cities? Yes, of course it did, at least that part of the servicing which demanded major repairs. The volume of business that results from periodic tube checking, balancing and minor adjustments was just so much business lost.

At the suggestion of the writer, DeLancy Brown operating the Brown Radio and Refrigeration Service in the village of Dundee, N. Y., purchased the necessary testing equipment and opened a service shop. That was eight months ago. Each month since the opening, Brown's tube sales alone have passed the half hundred mark. Peak months have tripled the figure. This spring he is finding it necessary to employ an additional serviceman.

Survey For Best Spots

A survey of the town and the surrounding area shows that of 1200 or more sets in operation, three-quarters of them had not been balanced, tubes not tested, or other minor items looked after, in over a year. Of course there were some sets that hadn't been checked for years, still using those so called ageless tubes, responsible for tone-deafness.

In many cases the set had been

taken to the nearest city for repair but only as the result of complete breakdown. In other words, acute radio troubles were treated in cities 30 miles or more away, but no treatment at all were given the chronic cases.

Using local newspaper advertising, plus direct mail and personal calls to the nearby and outlying homes, Brown has, successfully, obtained a large share of the breakdown servicing requirements and the profitable business of tube replacements and other operating items.

Consult Jobbers

The serviceman having read thus far, will ask how do you go about finding such locations? The answer is with the parts jobber salesmen who cover the small towns. Naturally they are familiar with the rural districts and could give a good idea on likely locations for a service station.

First obtain the population figures of the town, divided by three to estimate the number of radio receivers in use. Then, from the local post-office, find the number of box holders and RFD stops on rural routes leading from the village. This postal figure reduced by 25 per cent will give you the approximate number of out-of-town sets in the trading area. The sum total of these two will give a very fair estimate of radio owners. If the total is one thousand or more, the location should prove profitable.

Pick your location to be at least 20 miles from the big city. The large cities with their "do it for nothing" prices will not aid the small town serviceman.

In summation, small town servicing will prove to be more profitable in many cases than city repair work, because operating costs are lower yet service charges can be higher than for similar work in a metropolitan location.

INTERESTED?

BOTHERED by severe competition . . . high overhead . . . low job prices? This novel idea may help you

BIG SPACE — New disc department at Stewart's, Louisville, is one of the most striking in the country



SMALL SPACE—Developed for W. T. Grant, this merchandising counter does a job, requires little floor area



RECORDS on DISPLAY

FOUR HINTS about showing your wares



MASS—Milt Gabler of Manhattan's Commodore Music believes in making it obvious that he has a complete disc stock

WINDOW—Good example of a tie-in with a popular album is this New York display

WHITE SOUND SERVICE
151 WEST 43rd STREET
NEW YORK, N. Y.
TRefalgar 4-3022



Public Address Amplifying Systems
Custom-Built Electric Phonographs
16 MM Sound Film Projectors
Radio Program Recording
Sound Trucks

Union Service

March 26, 1940

City-Wide Advertising Corp.,
110 West 40th Street,
New York, N.Y.

Gentlemen:

RENT OUR SOUND TRUCK FOR EFFECTIVE NEIGHBORHOOD ADVERTISING.

Use "ear-appeal" as well as eye-appeal in advertising special sales, new store and theatre openings, new products, sporting events, bazaars, dances and for all purposes where a direct and powerful message must be driven into the consciousness of the public.

You don't have to send an announcer with our sound cars. We will make a phonograph record which contains the message desired.

Our sound truck is a new and attractive vehicle, painted white and makes a smart impression. It is equipped with a high-powered amplifier capable of reproducing speech and music with good quality that is pleasant to hear.

Yours very truly,
WHITE SOUND SERVICE



Public Address Amplifying Systems
Electric Phonographs
16 MM Film Projectors
Recording

1940.

National Advertising Corp.,
Chicago, Ill.

Gentlemen:

As your company is handling the advertising for BUICK MOTORS, we should like to suggest the use of our sound equipped vehicles as a fresh and effective method of bringing new models of Buick to the attention of the public.

We can furnish smartly designed trailers, painted with Buick slogans, also carry literature and photographs for distribution to the public.

Modern sound equipment will furnish a pleasant atmosphere of music. Spotlights will keep the name of Buick illuminated during evening hours. We are also prepared to show outdoor motion pictures depicting the manufacture and salient features of your product.

May we call upon you and explain this project in greater detail.

Yours very truly,

ADVERTISING is our greatest service industry. The money spent in this industry runs into hundreds of millions of dollars annually.

Practically every product made in this country gets to the consumer because of suggestions imparted by one or more advertising mediums. Without advertising neither Pinkham Pills nor Planter's Peanuts could receive the renown they possess.

You've Got Something

Sound truck advertising furnishes a fresh and powerful medium for carrying a message to the public, but most advertisers and agencies have not been educated as to its effectiveness. It is now up to the sound dealer to sell outdoor advertising to advertising executives and agen-

* Sound Specialist

cies. What the advertiser wants is results, and the sound truck can bring it like nothing else.

In the course of an 8-hour day a truck can travel 60 to 100 miles through the congested streets of a city and attract the attention of hundreds of thousands of persons. The dealer should take a dignified stand and sell sound truck service as a newspaper sells space, that is, on circulation, or "interest-creating value." On this basis, sound truck rates should approach that of a printed medium of equivalent circulation. In large cities \$50 to \$75 per day per truck is not unreasonable if based on the principle of circulation. On a weekly contract basis, the rate should be around \$250 per six-day week.

One of the frequent objections made by advertisers is that this type of service is "not dignified." This claim is partially correct, and it is

Selling

Outdoor Advertising

By

**SOLBERT
J. WHITE***

up to all dealers to once and for all remove this stigma.

The sound truck should be smart-looking, the equipment of good quality, especially for playing music.

How To Merchandise It

Look up the advertising agencies in your city, visit them one by one and suggest they try your sound truck.

Some large newspapers publish a column of "Advertising Notes." Consult this column as it will reveal what new advertising campaigns are being planned by large companies. This column will indicate the name of the advertising agency through whom the money will be spent.

Don't be afraid to go after large national advertisers. In fact, you should be so bold as to advance the idea of a fleet of trucks to be equipped by you for a cross-country tour. It has been done before.

Don't be chicken-hearted because only small fry companies have hitherto been your sole customers. It is the large national advertisers that spend millions in newspapers and magazines. We sound dealers *must* horn in on some of that.

Try the automobile dealers in your community. When a new model of a car comes out, propose that you place the car on a float equipped with sound.

If you are located in a coastal city, sell someone the idea of a sound equipped boat to tour the beaches. Wherever you see a vacant store being furnished, sell the proprietor on the idea of sending your truck out to inform the public of his opening. If a super-colossal picture is scheduled for a movie-house, get the manager to use your truck for advance advertising.

BUILDING YOUR SOUND BUSINESS

**Second of a Series About
DEVELOPING NEW MARKETS**

THIS COUPON

is so Important
we're putting
it **ON TOP** ★
so You can't miss it

MAIL FOR MONEY FACTS

AIRTEMP DIVISION,
Chrysler Corporation,
Dayton, Ohio.

Please rush profit-making facts about the new AIRTEMP Summer Air Conditioners and *proof* that my present sales force can sell them *fast* and at a man-size profit.

Name

Address

City..... State.....

(Do you handle Room Coolers now? If so, please give make.)

Facts—

- ① Your Present Sales force can sell it.
- ② No Trade-ins—no allowances.
- ③ A COMPLETE line.
- ④ A Man-size Profit on every sale.



—that's what
You get when
You Hook up with

AIRTEMP
Summer Air Conditioners

"PACKAGED" PLUG-IN TYPE

NO PLUMBING

NO WIRING

In a recent magazine article, one well-known writer said of "Packaged" Summer Air Conditioners, "Here is a new business with . . . a big dollar profit and with the greatest potential customer repeat business ever seen in the electrical appliance industry."

This is especially true of AIRTEMP Summer Air Conditioners because they're different from all others in several important ways. They not only *cool* the air, but, also, dry, filter and circulate it while shutting out street noise.

Handsome, modern, grained-wood finish, steel cabinet. A design to harmonize with any interior. Adjustable height. The lower the window, the lower the top of the cabinet. Room air adjusts up or down—instantly. In larger model, air can be directed to either side. Pressure-lubricated "Radial" compressor direct driven by heavy duty electric motor. Essential machined parts "superfinished" to 1/1,000,000 of an inch! Exclusive Chrysler feature. Result, perfect balance—

**Be sure to
Mail Coupon**

highest efficiency—least wear. Fan unsurpassed for *silent* efficiency. Quickly, easily installed. No plumbing. No permanent wiring. Just plug in like lamp or radio.

Made, sold, and backed by Airtemp Division, Chrysler Corporation.

CASH IN BIG

You can't go wrong with air conditioning units like this. So don't take chances on something that's supposed to be "just as good as AIRTEMP." Hook up now with the line of BIG, FAST-SELLING Profit Producers.

AIRTEMP DIVISION, Chrysler Corporation, DAYTON, OHIO



**SELL the idea of
WORKING BETTER**



**SELL the idea of
FEELING
BETTER**



**SELL the idea of
SLEEPING BETTER**



SCHOOL ORCHESTRA'S GOOD BET—Here's a shot of the author in action, cutting a disc for the University of Nebraska's Donald Lentz, conducting an orchestra composed of young high school musicians from Osage, East Waterloo, Sumner and Charles City during a recent "music festival"

Getting Started in RECORDING

By **BOB WRIGHT***

FOR OVER A YEAR, without much capital outlay or promotional expense, I have been quietly making extra money with a recorder. It occurs to me that my experiences in this interesting and profitable game may be useful to others who wish to give it a whirl on a modest scale.

Before I go on to these experiences, however, let me say that regardless of the basis upon which radio or sound men enter the business it is futile to just stock a machine or two and then expect sales to wander in of their own accord. Recording is highly interesting to the public at this moment but by no means does everybody know about it. You've got to just deliberately wave it under their nose at every opportunity.

Keeping First Costs Down

Studios, so frequently illustrated in the magazines, are no doubt advantageous but they are not absolutely essential to the recording beginner.

Home setups, I can say from experience, are generally quite satisfactory for recording the average talk, singer or small orchestra having four or five pieces. I have even recorded larger orchestras in places not exactly ideal from an acoustic standpoint by placing my mike in a doorway, picking up the sound as it came through the opening and so minimizing echos. If you can in-

duce musicians to play softly this, too, helps.

Recorders can be made the focal point of many club meetings or similar gatherings. The rub usually arises when one or more of the group becomes overly modest, or gets mike fright, and does a poor job of talking about himself. You can get around this nicely by getting each speaker to talk not about himself but about the next man, permitting each one to introduce his neighbor. This is an old get-together trick and it works surprisingly well.

Here's another good trick for meetings, especially amateur theatricals. Tell the master of ceremonies that your volume level indicator makes a swell "applause meter." Adjust the gain so that the needle reads nearly full scale with everyone clapping full blast and, during contests judged by applause, tip the judges off on the readings.

Another suggestion: Despite the fact that high school teachers should welcome recording with open arms you will find, curiously, that many of them are so set in their ways that you meet more sales opposition than you expected. Try telling them that most of the big colleges are now using recorders, at least in their speech and music departments, and you will find that they will thereafter listen to your story more readily.

I have found that it is possible

to make duplicate records of good quality by using two recorders. I swing the pickup around so that it will track properly on a turntable set to the side of the recorder. In such cases the record to be dubbed is set on the extra turntable and fed through the recording amplifier and cut as usual.

Other Useful Tricks

It may also be of interest to beginners to know that when recording a series of short messages, such as at a club meeting, it is quite possible to get about forty people on the two sides of a ten-inch record. I've done it where the club wanted to minimize expense. I may agree to hold disc cost down in this manner and even to furnish the service occasionally at an extremely low price where I think later business is definitely involved but, as in the sound business, I never under any circumstances go farther and donate my recording services without charge just for the "advertising."

Above all, in conclusion, let me advise other men now getting into recording not to make the same mistake I did, assume that applications initially coming to mind are far-fetched. When in doubt about an application go out and try to sell it.

While I have been in the game for over a year and the Little Brown Church in the Vale is only fifteen miles from here it was only last week that I made my first recording at this famous shrine.

* Radio—Sound sales & service

Man! This "KIT PLAN" really builds VOLUME and PROFIT for dealers!

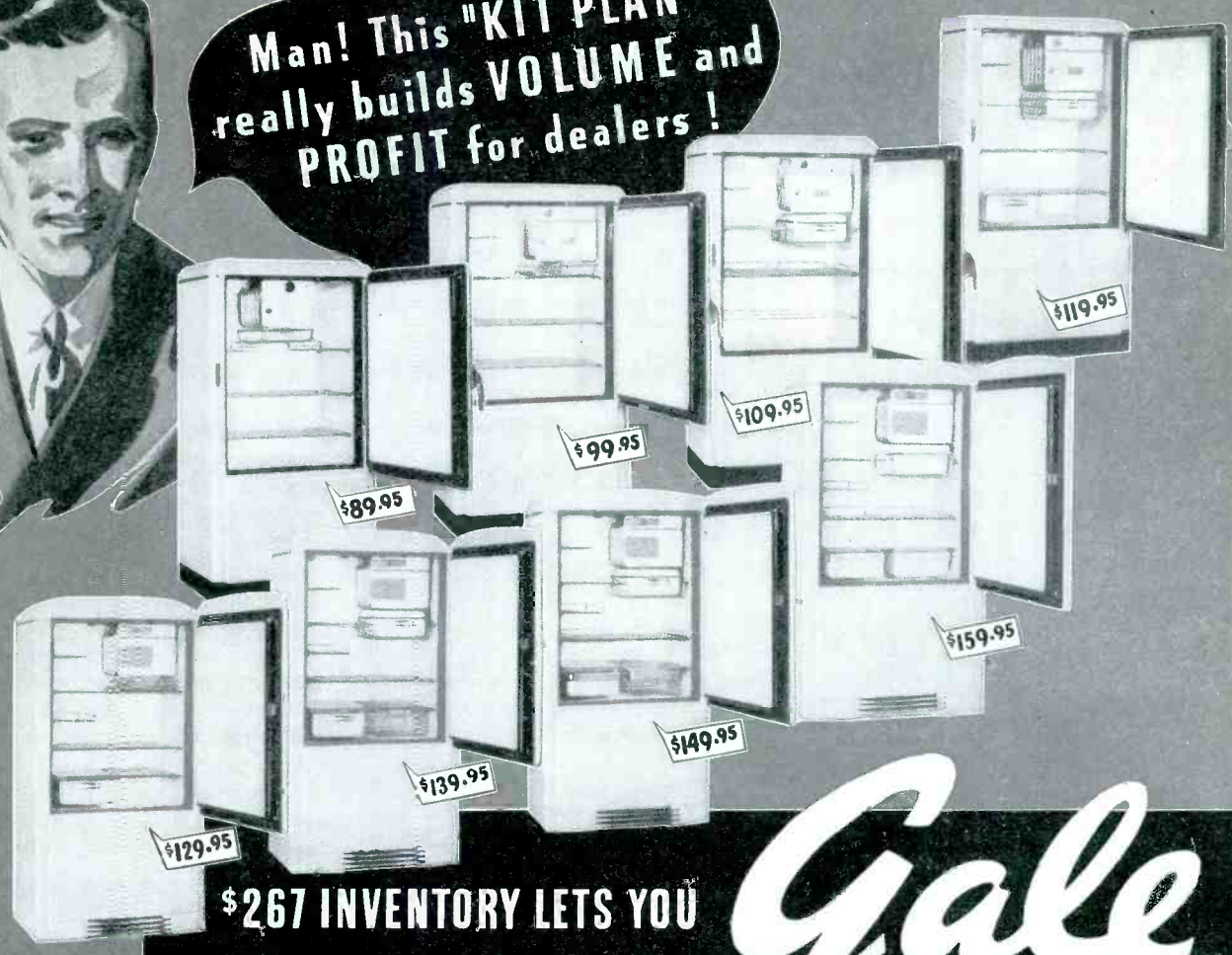

\$267 INVENTORY LETS YOU SHOW THESE EIGHT 6.6 FT.

Gale
MODELS

Unbelievable? Then you don't know the Gale 'Kit Plan'! These "six-foot" above give you just an inkling of the tremendous advantages you can gain by using the Gale 'Kit Plan'! You can't afford to pass it by, because, regardless of what other line you may be selling, you need the powerful competitive advantages that only Gale offers. In addition to the profit-building features of the Gale 'Kit Plan', you get a line that hits hard with eye appeal, features, quality and price. Increase your volume and profits with Gale!

GALE PRODUCTS
GALESBURG, ILLINOIS
In Canada, GALE Products, Peterboro, Ontario

Division of Outboard, Marine and Manufacturing Co.



Don't overlook the extra profits you can make with packaged air conditioning. Gale Portable Air Conditioning Units are easy to show — easy to sell — easy to install.



Here's the booklet that shows you graphically just how the Gale 'Kit Plan' works. It's free. Send for your copy today.

GALE Products
1627 Monmouth Blvd.
Galesburg, Illinois

GENTLEMEN:
Send facts on Gale refrigerators and Gale Kit Plan
Rush full information on Gale Portable Air Conditioning Units

COMPANY _____
STREET _____
CITY _____ STATE _____
BY _____ TITLE _____

REFRIGERATION

is *EASIER* to Sell . . .

BUT YOU HAVE TO KNOW HOW,
otherwise people will buy radios faster

By CASWELL ODEN*

THE RADIO DEALER was thinking of taking on a line of refrigerators. But he realized that, in spite of all "that guy Oden" says about how *easy* they are to sell, there's a lot more to *selling* one than there is to selling a radio. And he was wondering if those three men of his actually *would* do a good job with boxes. . . .

It's a fact that there is "a lot more" to selling a box than there is to selling a radio. So in spite of the fact that a box actually is very easy to sell, far easier to sell than a radio once you know how, there is a prevailing opinion (mostly among those in the business who do *not* do the selling) that it is not. Or that super salesmanship is "required" to sell a box . . . whereas almost anybody can sell a radio—anybody who can turn a dial, tune a set and quote a price.

Looks Harder At First

It's a fact that we need more *training* to sell a box. But we don't need more ability. For example, we might sell a radio with no training at all; we couldn't do that with the box. Nevertheless, after we receive the training, on both, we find the box easier to sell. This is because:

Training, naturally, increases ability, whether it be on the box or the radio—but not in the same proportion. This is because: when we are trained to sell a box we are trained to sell something which can

* Salesman

WHY SOME DEALERS DOUBT IT

ABILITY, the straight garden-variety of "salesmanship sense," will move some sets

TRAINING, however, pays proportionately bigger dividends in connection with boxes

be "sold" and is therefore susceptible to training; when we are trained to sell a radio we are trained to sell something which will still be "bought," not sold, even after we have received our training.

For instance, we could put a boilermaker on our floor and he might sell two or three radios the first day. But there is very little chance that he would sell a box, no matter what kind or quality of prospect came in.

With the radio, our b.m. would know enough to tune the set. There'd be a price tag on it. The prospect would already be educated to the need. And as far as competitive sets are concerned, he could look at our set and listen to it. Then if he wanted it he'd give our b.m. the order. (Not quite as easy as that, but you get the idea).

With the box, our b.m. would be out of luck. There is the convenience and the economy to *sell*. And even if the prospect was already sold on that, there would still be the features of the box itself to present. That amounts to more than playing a set.

Then You Discover Something

Granted, then, that we need more training to sell the box. Now let's give our b.m. the training. He's been working for us a year. He knows all about our merchandise, and he has become a good salesman. He's pretty hot, in fact. He's just rubbing his hands together and waiting for somebody to walk in.

In comes a person and looks at a radio. You know the story. I'm not going to repeat it. Our man will sell the radio, if the person wants it. But no matter how good a salesman he has become and no matter how much he knows about our radios or radio in general, he won't sell it unless the person really wants it and

wants it enough to decide to buy it. That is because our man doesn't have a "sales talk." And you can't be good at something which doesn't exist. His training, of course, has helped him. It has helped him to do a better job of *showing* the set.

In comes a person to look at a box. That's entirely different, but I'm not going to repeat that story either. Briefly our man, now that he is trained, not only points out all the features of the box but shows the prospect that he can get it for nothing. He has a sales talk, an irresistible one, and he uses it. And it is possible to become very good at something which exists.

You Can Create Business

So to sum it all up in a few words, the *impression* that a box is harder to sell than a radio is due to the following facts:

With the box, we *have* a sales talk. Having it, we *use* it. Consequently, when a box is sold, "salesmanship" was used to sell it—but for no other reason than that it **COULD** be used.

With the radio, we *don't* really have a sales talk. Not having one, we *can't* use one. Consequently, when a radio is sold, the sale seemed comparatively easy—for the simple reason that it **HAD** to be easy—otherwise it would not have been consummated.

All this was true, of course, when we were selling boxes on 36-month and 30-month contracts. Now that we can allow even longer to pay, a refrigerator is still easier to sell.

Remember when I said we ought to figure it so that the box would cost the lady about \$1.00 a month, net? I take that back. On new finance plans we ought to figure it so that the box costs the lady *nothing*.

And that's no sales talk. It's the truth!

Make Your Refrigerator Business Profitable with Hotpoint's Plus Features and Friendly Finance Plan

\$6⁰⁰ DOWN
\$4⁵⁰ Per Month



6.1 Cu. Ft.

FEATURES OF ALL HOTPOINT REFRIGERATORS

- Vacuum-sealed Thriftmaster.
- Stainless steel Speed Freezer.
- All-steel construction.
- Thermocraft insulation.
- Interior light.
- Porcelain interior.

\$6⁰⁰ DOWN
\$6⁰⁰ Per Month



6.2 Cu. Ft.

PLUS:

- Larger Capacity.
- New Design.
- Pop-Ice Trays.
- Nine-Piece Dish Set.
- Vegetable Pan.

\$6⁰⁰ DOWN
\$6⁰⁰ Per Month



6.2 Cu. Ft.

PLUS:

- New Design.
- Meat Storage Pan.
- Fruit Basket.
- Ovenproof Pottery.
- Tip-up Shelf.

\$6⁰⁰ DOWN
\$7⁰⁰ Per Month



6.2 Cu. Ft.

PLUS:

- New Design.
- Hi-Humidity Compartment.
- Stainless Steel Shelves.
- 6-Way Cold Storage.
- Vari-Colored Ovenproof Pottery.

\$8⁰⁰ DOWN
\$8⁰⁰ Per Month



6.2 Cu. Ft.

PLUS:

- Measured Humidity.
- Illuminated Control.
- Half-Gallon Dessert Tray.
- Food Safety Gauge.
- Deluxe Ovenproof Dish Set.
- Lucite Nameplate.
- Air Purifier.

\$8⁰⁰ DOWN
\$8⁰⁰ Per Month



6.2 Cu. Ft.

PLUS:

- Larger Capacity—Dish Set.
- Vegetable Pan.

\$9⁰⁰ DOWN
\$9⁰⁰ Per Month

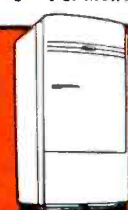

6.2 Cu. Ft.

PLUS:

- Measured Humidity.
- Stainless Steel Adjustable Shelves.
- Illuminated Control.
- Food Safety Gauge.
- Dessert Tray.
- Ovenproof Pottery.
- Air Purifier.

\$10⁰⁰ DOWN
\$10⁰⁰ Per Month

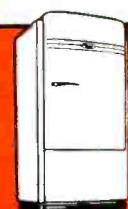

6.2 Cu. Ft.

PLUS:

- All-Porcelain Exterior.
- Vari-Colored Deluxe Dish Set.

"Step up" into the
PROFIT ZONE

*Use the Great "Price" Leader to get into the
PROFIT ZONE with Hotpoint's Friendly Finance Plan!*

Hotpoint offers Sensational Terms to help "Step-up" Sales into the Profit Zone!

*As simple as this . . . Now you can say
"only a few cents a day" and mean it!*

- 1 Show customers the low-price Hotpoint leader when they ask to see it.
- 2 Next show a Deluxe model and explain the "Plus" features.
- 3 Explain that the down payment on the better model is practically the same as the cheapest. Monthly payments are only a little more.
- 4 Plus features at only a "few cents a day more" put you in the Profit Zone.

*Write today for full information about
Hotpoint Refrigerators and the PROFIT ZONE.*

EDISON GENERAL ELECTRIC APPLIANCE CO., INC., 5680 West Taylor Street, Chicago, Illinois



Hotpoint

ELECTRIC REFRIGERATORS

with Measured Humidity

ELECTRIC RANGES • WATER HEATERS • WASHERS AND IRONERS • CLOTHES DRYER
DISHWASHERS • ELECTRASINK

For Summer Sales and Profits...

PHILCO



**Refrigerators
Air Conditioners
Auto Radios
Portables**

New, Advanced Design
PHILCO REFRIGERATOR

**The Fastest-Selling Quality
Refrigerator on the Market!**

Already, the sensational new 1940 Philco Refrigerator has become the quality leader in the refrigeration field, *selling in volume* at a higher price and a bigger profit to the dealer! The answer is **ADVANCED DESIGN** . . . that offers valuable, *extra services worth the money* to the buyer!

No more wasted space in the center of the refrigerator! Philco discards the old-fashioned freezing unit and gives you, instead, the Horizontal Evaporator and *separate, giant-size Frozen Food Compartment*. Selling features found in no other refrigerator at any price! Supported by the hardest-hitting promotion in refrigeration history! This is your greatest opportunity for refrigerator profits in 1940. Sell Philco and **SELL UP!**

Philco All Year 'Round Means Profits

HOME RADIO • PHONOGRAPHS • TELEVISION • AUTO RADIO • RADIO TUBES • PARTS • REFRIGERATORS



Amazing New Retail Business!
PHILCO-YORK AIR CONDITIONERS

The new, low-priced Philco-York Portable Air Conditioner for home and office opens a whole new field of profit opportunities! Gives you real, complete air conditioning in easy-to-handle, package merchandise. Easily, quickly installed . . . no plumbing . . . no wiring. Plugs into any electric socket. Practically every home and office is a prospect . . . there's a model to fit every need. **FULL PROFITS . . . no trade-ins!** Supported by strong advertising campaign!



Only Philco Gives You
SHORT-WAVE AUTO RADIO

New features bring amazing performance and convenience that make the new Philco the easiest-to-sell auto radio in the field.

Philco's amazing new SHORT-WAVE AUTO RADIO makes every car owner a prospect whether he has an auto radio or not! Tunes in foreign stations *direct*. Enables you to switch to American short-wave broadcasts when standard reception is difficult. New sales . . . new profit opportunities! *Only Philco has it!*



Selling Fast! New 1941 Line of
PHILCO PORTABLES

Smart new textures and color patterns . . . brand new performance features . . . new design that gives far greater portability. And what values! Cash in on the tremendous demand for Philco Portables. Get your share of summer profits in the amazing Philco Radio and Radio-Phonograph values your distributor is offering now!

**Mail
 Coupon
 NOW!**

PHILCO, Dept. 608

Tioga and C Streets, Philadelphia, Pa.

Please tell me more about the Philco All Year 'Round profit opportunities. I am particularly interested in

- Philco Radios and Radio-Phonographs
- Philco Auto Radios
- Philco Refrigerators
- Philco-York Air Conditioners

NAME _____

STREET _____ COUNTY _____

CITY _____ STATE _____

All Year 'Round!

ATORS • AIR CONDITIONERS • DRY BATTERIES

GENERAL ELECTRIC **FIRST** IN FREQUENCY MODULATION



MODEL HM-136
A 4-band radio that tunes in Standard American Broadcasts, Foreign and Domestic Short-wave Stations, as well as the new Frequency-Modulation Broadcasts.

General Electric was *the first* manufacturer to foster Frequency-Modulation Broadcasting—*the first* to introduce Frequency-Modulation Receivers—one of the pioneers to offer a full line of Frequency-Modulation Transmitters!

Follow the leader! Keep up to date! Find out what General Electric is doing to promote this new type of broadcasting and reception.

RADIO & TELEVISION DEPT.
BRIDGEPORT, CONN.

Special F-M Receivers

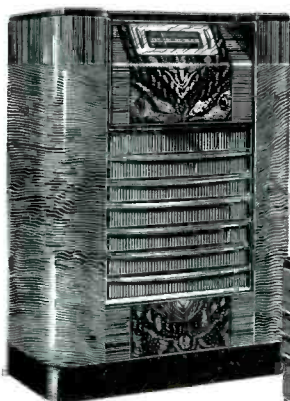

← **MODEL HM-85**
Tuning Range: Frequency-Modulation—39 to 44 megacycles. Dynapower Speaker. Exquisite Cabinet.

MODEL HM-80
Dynapower Speaker—Slide-rule, Full-vision Dial—Smartly Styled Cabinet. Tuning Range: Frequency-Modulation—39 to 44 megacycles.

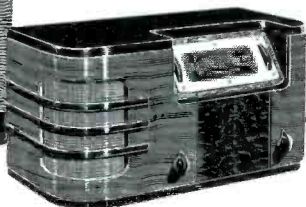

THE NEW G-E FREQUENCY-MODULATION TRANSMITTERS

Fine new models—with output ratings of from 250 watts to 50 kilowatts! This outstanding equipment—engineered by G.E.—hits a new high in high-fidelity broadcasting. Distortion is less than 1½ per cent from 30 to 7,500 cycles and less than 3 per cent up to 15,000 cycles! Investigate! The demand for General Electric F-M equipment is growing rapidly.



LOOK TO GENERAL ELECTRIC FOR FREQUENCY-MODULATION! TELEVISION! RADIO!

GENERAL ELECTRIC

Product Preview



STEWART-WARNER

COMPACT—Model 4B1, 4-tube single-band battery set intended for rural homes. Uses the low-drain 1½ volt tubes with 3 external dry cells or by means of an adaptor plug can operate from a medium or standard power pack.



TABLE TYPE—A 6-tube set using 2 dual-purpose type tubes and incorporating a.v.c., a 3-position tone control; phono-switch; and 6 pushbuttons. Model 6G1 has three tuning bands from 540 to 18,400 kc. also provision for television sound. Stewart-Warner Corp., 1826 Diversey Parkway, Chicago, Ill.

PHILCO



PORTABLE—Model BIT is a light-weight battery operated portable enclosed in a slim model case covered with airplane luggage fabric and Buffalo style graining. It is a 4-tube unit with an improved built-in loop. Price \$19.95 complete with battery. Philco Radio and Television Corp., Philadelphia, Pa.

CROSLEY

AUTO RADIO—Six-tube motor car set, model A160, includes new current saving rectifier; tone control; and 5-push-buttons. Designed for easy installation. Separate speaker available for either dash mounting or built-in grille. Dimensions 5 by 5¾ by 12¼ inches. The Crosley Corporation, Cincinnati, Ohio.



AUTOMATIC



RADIO-PHONOGRAPH—Model 432, a 5-tube superhet walnut table combination for alternating-current operation only. Crystal phono pick-up; built-in antenna; and automatic volume control. Automatic Radio Mfg. Co., Inc., 122 Brookline Ave., Boston, Mass.

EMERSON

TABLE TYPE—"Campaigner" model DQ333 is an a.c.-d.c. 5-tube superhet with beam power output; a 6½ inch electro dynamic speaker; and a power line noise filter. Enclosed in a bakelite cabinet 12¾ by 7¼ by 6 inches. Price \$12.95. Emerson Radio & Phono Mfg. Co., 111 Eighth Ave., New York, N. Y.



RCA

RADIO-PHONOGRAPH—Model U-45, combination set with record changer; loop antenna; push-button tuning; 12 watt output; and three tuning bands. Employs 9-tubes plus magic eye. Cabinet finished in solid and matched walnut veneers with trim of orientalwood.



TABLE TYPE—Model T-63, plug-in connection for television or phono attachment; 6 pushbutton; 2-band reception. Uses 5 metal tubes and has automatic tone compensation. Measures 19 by 10½ by 8 inches. RCA Mfg. Co., Camden, N. J.

LAFAYETTE



RADIO-RECORDER—Console model BB-96 combination 12-tube, 3-band high-fidelity receiver and professional type recorder. Acetate blanks up to 12 inches used for recording; turntable is rim-driven by self-starting heavy duty synchronous motor coupled through a rubber idler pulley. Playback pick-up is the crystal tangent-arm type. Radio Wire Television, Inc., 100 Sixth Ave., New York, N. Y.

ADMIRAL



BATTERY SET—Model 41B4, a 4-tube 1½ volt superhet featuring a 6 inch P.M. dynamic type speaker; easy to read dial; and the use of the 3QSGT power tube. Operates from an A-B battery pack.



PORTABLE—A 5-tube a.c.-d.c. or battery operated superhet housed in a brown leatherette cabinet. Built-in aerial; slide rule dial and heavy duty speaker. This model 34-F5, equipped with automatic power switch, lists at \$24.95. Continental Radio & Tele. Corp., 3800 Cortland St., Chicago, Ill.



ZENITH

ARMCHAIR TYPE—One of the first 1941 models to be brought out, is this 10 tube chairside model with 3 tuning bands, 6 pushbuttons, "Wave-magnet" built-in antenna and the "Radiorgan" tone color blending device, which permits the listener to blend radio tone to suit his own tastes. Zenith Radio Corp., 6001 Dickens Ave., Chicago, Ill.

OPERADIO

INTER-COMMUNICATION—This attractive call system for business and professional men permits

two-way conversation with all speaker stations regardless of the type of service employed. The system also provides facilities for "conference hookup" which allows 3 or 4 executives to converse with each other. Operadio Manufacturing Company, St. Charles, Ill.

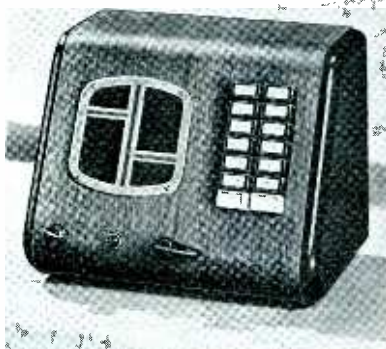

RADIO-PHONOGRAPH—Table model 533 "Baby Grand" combination phono-radio with the former capable of playing both 10 and 12 inch records. Radio is a superhet utilizing 5 tubes; has a built-in aerial and is enclosed in a two tone walnut cabinet measuring 16 wide, 13 deep, 8¾ inches high. Belmont Radio Corp., 1257 Fullerton Ave., Chicago, Ill.

WILCOX-GAY



PORTABLE—Combination battery, a.c.-d.c. set, model A73 enclosed in an attractive airplane luggage case with self-contained aerial. Five tube unit; dimensions 14½ by 5¾ by 9¾ inches. Wilcox-Gay Corporation, Charlotte, Mich.

MOTOROLA



AUTO RADIO—Model 550 a 6-tube pushbutton receiver designed to fit and match every car. Choice of either an 8 inch bulkhead or a matched dash-panel reproducer. List \$49.95. Galvin Mfg. Corp., 4545 Augusta Blvd., Chicago, Ill.

BELMONT

RECORDER COMBINATION—Model 797 is a 7-tube radio-phono and recorder. Set has two tuning ranges from 540 to 1840 kc. and 5.6 to 18.3 mc., uses a 10-inch speaker; built-in loop antenna; and 6 pushbuttons. The recorder employs a Light-O-Matic type level indicator to warn the operator against overloading record cutter. Microphone and cutter both of the crystal type. Size 33 high 31 wide, 15½ inches deep.



SETCHELL CARLSON

PORTABLE—New four-way portable "66" adaptable for the car using 6 to 8 volts; for the home, 110 volts a.c. or d.c., for outings with self contained batteries. No "B" batteries are required. Band coverage 540 to 1750 kc. Features loop antenna; 5-inch speaker; finished in two-tone pig-grain leatherette. Setchell Carlson, Inc., 2233 University Ave., St. Paul, Minnesota.



HOWARD

PRESELECTOR—Model 650 completely self-contained high gain two stage preamplifier tuning from 540 kc. to 43 mc. May be used with either of 4 separate loops supplied to indicate direction or with regular antenna connection. Howard Radio Co., 1735 Belmont Ave., Chicago, Ill.

when
batters
step up
to the
plate

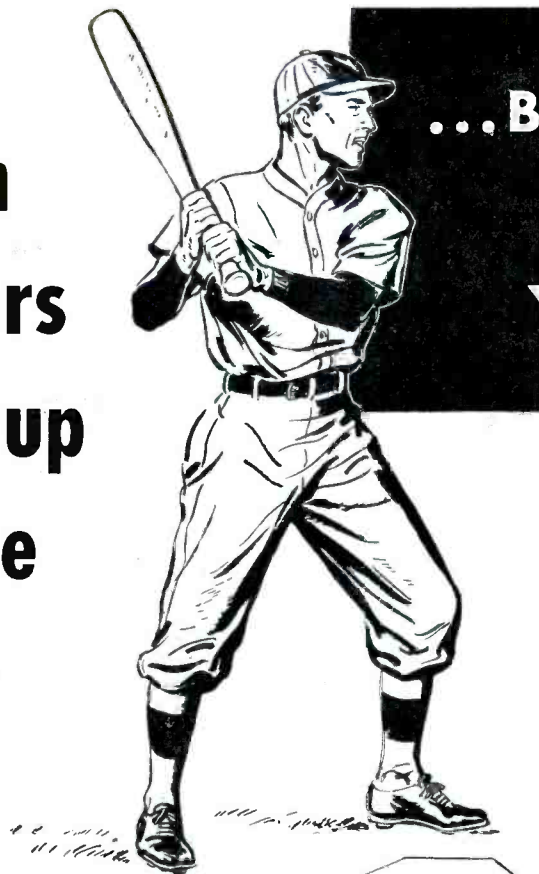

... BATTERY CUSTOMERS
STEP UP TO
YOUR COUNTER!

Baseball season is portable radio season... when portable sets start working overtime—and replacement buying of batteries swings into high.

To get your share of this replacement demand be ready to stock and push the sensational "Eveready" "Mini-Max" "B" battery—the battery that makes portable sets really portable!

The "Eveready" "Mini-Max" "B" battery has set a brand new standard for portable "B" battery size and performance. Combining minimum size and weight with maximum power it delivers twice the service life of any other "B" battery of equal size. That's why approximately 30 leading manufacturers have designed portable sets using this remarkable battery.

Be sure you have enough "Eveready" "Mini-Max" "B" batteries on hand to take care of demand that's starting now. Order today for extra profits tomorrow!

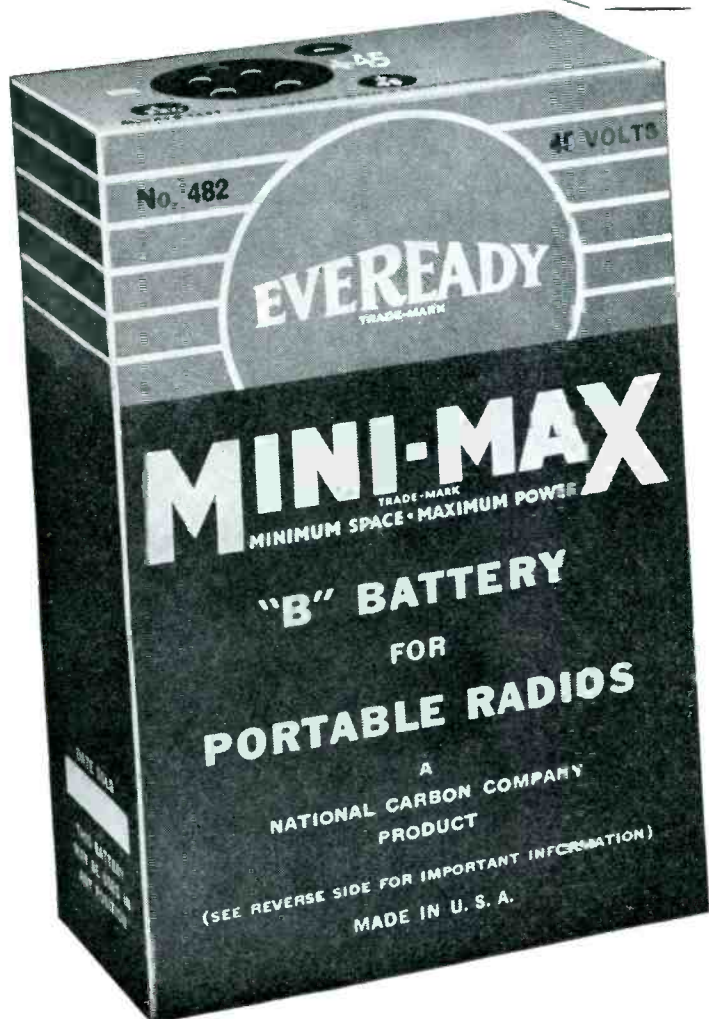

These leading radio manufacturers have designed sets to use the "Eveready" "Mini-Max" "B" battery—

ARVIN	MOTOROLA
AUTOMATIC	NAMCO
COLONIAL	PACKARD BELL
CROSLY	PILOT
DETROLA	RCA
DEWALD	SENTINEL
EMERSON	SONORA
FADA	SPARTON
FARNSWORTH	STEWART WARNER
GAROD	STROMBERG CARLSON
GENERAL ELECTRIC	TELEX
GENERAL TELEVISION	TRAY-LER
GILFILLAN	TROY
HOWARD	WARWICK
KADETTE	WESTINGHOUSE
MAJESTIC	WILCOX-GAY
MISSION BELL	<i>And Others!</i>

NATIONAL CARBON COMPANY, INC.

General Offices: New York, N. Y.

Branches: Chicago and San Francisco

Unit of Union Carbide and Carbon Corporation



The words "Eveready" and "Mini-Max" are registered trade-marks identifying products of National Carbon Company, Inc.

HALLICRAFTERS

COMMUNICATION RECEIVER—Model S27 ultra high-frequency set to cover the regular and experimental services utilizing wavelengths down to 2 meters. Three ranges from 27 to 145 megacycles. Reception of both amplitude and frequency modulated signals; 15-tubes in all with acorn types in the r.f. and converter stages. Hallcrafters, Inc., 2611 S. Indiana Ave., Chicago, Ill.



RCA

AMPLIFIER—Model MI-12205, a 25-watt sound system designed as an integral unit with a two-position mixer MI-12208 and a 20-watt speaker MI-9430A. Modern styling used throughout in the construction of the amplifier. There are provisions for mixing up to four microphones. Available for either 110 volt 50-60 cycle or 25-60 cycle line supply. RCA Manufacturing Company, Camden, N. J.

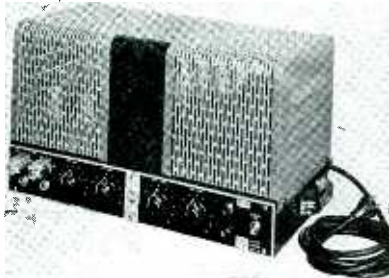

TALK-A-PHONE

INTER-COMMUNICATION—This company producing line of page system power amplifiers with built-in speakers. For use with standard intercommunication master stations. Units made in 5 to 15 watt sizes. Talk-A-Phone Mfg. Co., 1847 S. Millard Ave., Chicago, Ill.

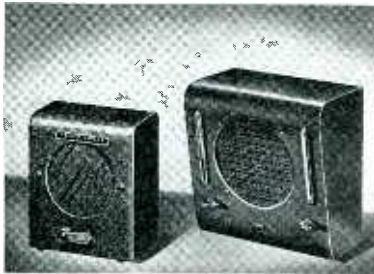

SOLAR

CAPACITORS—New Red-Caps have uniform length, but diameters are much less than heretofore offered. Several units strapped together occupy no more space than the original filter. Servicemen can in this way make their own filters. Sealed in metal tubes. Solar Mfg. Corp., Bayonne, N. J.



AMPERITE

MICROPHONE—This company introduces a new pressure gradient dynamic type mike with improved ellipsoid pickup pattern. Output level —55 db., and they point out the familiar mechanical sound due to diaphragm peaks is eliminated resulting in a natural response curve from 40 to 10,000 c.p.s. Model PGH list \$32.00, model PGAM, \$25.00. Amperite Company, 561 Broadway, New York, N. Y.

ATLAS

SPEAKER UNITS—A series of three "Dyna-Flux" P.M. compression units for use with reflexed projectors. Magnetic material used, nickel, aluminum, and cobalt alloy (alnico). Features non-corrosive diaphragm and protection from adverse weather conditions. Price left to right, model PM23, list \$30.00, PM25, \$45.00, PM26, \$50.00. Power ratings 18 to 20 watts, v.c. impedance 15 ohms. Atlas Sound Corp., 1449 39th St., Brooklyn, N. Y.



THORDARSON

AMPLIFIER—High-fidelity model T30W10 amplifier using 10 tubes and featuring an audio-frequency equalizer circuit. Output 10 watts; mounted on 19 inch panel for rack or available in grey metal cabinet as illustrated. With equalizer controls at normal response, within plus or minus 1 db. from 30 to 15000 c.p.s. Price \$250.00. Thordarson Electric Mfg. Co., 500 W. Huron St., Chicago, Ill.



BROWNING



MONITOR—Type S-1 is a precision custom-built frequency monitor, checking any 3 bands of frequencies from 1.5 to 60 mc., 100 kc. crystal osc. provides at least 2 check points in any band; cathode ray indicator allows accurate visual check against crystal standard as well as against transmitter; portable, a.c. or d.c. operation. Browning Laboratories, Inc., 750 Main St., Winchester, Mass.

TRIUMPH



TESTER—Model 334 "Utilitester," all-purpose general test instrument. Employs 3-inch meter, resistance 0 to 1 megohm, voltage readings 0 to 3000 a.c. and d.c., ma. 0 to 300, decibels minus 6 to plus 64, sensitivity 1000 ohms per volt. Size 5 3/16 by 7 1/8 by 2 3/8 inches. Price \$13.95. Triumph Mfg. Co., 4017 W. Lake St., Chicago, Ill.

CLAROSTAT



CONTROL—Series C1B output attenuator to control individual speakers in a sound system. Designed to dissipate 10 watts at any setting. One-hole mounting, unit can be installed in power amplifier or at individual speaker, range in 3 db. steps to 24, and then a 6 db. step, with final step to infinity. Stock ohmages 8, 15, 50, 200, 250 and 500 ohms. Clarostat Mfg. Co., Inc., 285 N. Sixth St., Brooklyn, N. Y.

"THE WINNING OF THE WEST"

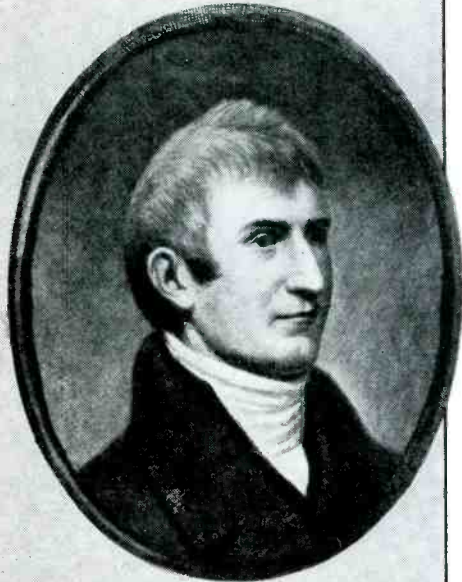

CAPTAIN MERIWETHER LEWIS

The Tale that Took a Hundred Years to Tell!

In the year 1803, Captains Meriwether Lewis and William Clark with a small band of fearless followers, pushed far into the American Northwest. Theirs was an expedition of vital importance to the newly born United States. It was the first chapter in the American saga of the "Winning of the West." But it was a chapter that remained closed to Americans until 1903...a century later...when the complete journals of Lewis and Clark were discovered and published. Theirs was the tale that took a hundred years to tell!



CAPTAIN WILLIAM CLARK

The family of RCA would have given America a running account!

FROM the moment Lewis and Clark ventured into the unknown, NBC engineers and announcers would flash news of their progress out over the two great NBC broadcasting networks. Portable RCA broadcasting equipment would acquaint the public with the aims of the Expedition through the actual voices of its leaders. Forty-three foreign nations would hear of America's new claim directly via R. C. A. Communications, the world-wide radio message service of the Radio Corporation of America.

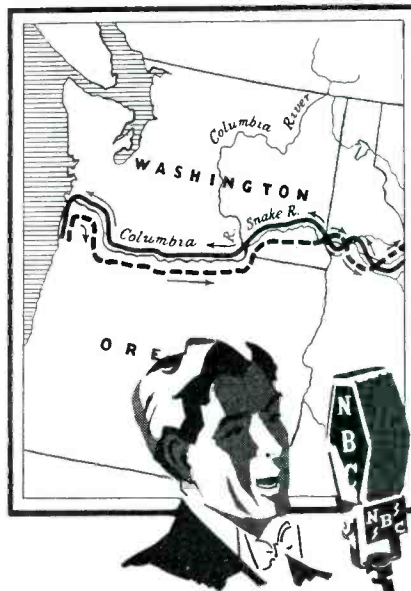

The antennae of ships in the loneliest oceans would snatch the news — thanks to another RCA service — Radiomarine. RCA Victor receivers would bring news about Lewis and Clark to listeners all over the world. Talking motion pictures would record their doings through the RCA Photophone Magic Voice of the Screen.

Service through sound and sight! That is... and will continue to be the duty and responsibility of the family of RCA to the people of America... and to you.



RADIO CORPORATION OF AMERICA RADIO CITY, N. Y.

RCA MANUFACTURING Co., Inc.
 RADIOMARINE CORPORATION OF AMERICA
 NATIONAL BROADCASTING COMPANY
 R. C. A. COMMUNICATIONS, INC.
 RCA LABORATORIES
 RCA INSTITUTES, INC.

RADIO CITY

MULTIMETER—An all-purpose portable instrument, model 411P, offering alternating and direct current ranges up to 25 amperes; a d.c. range down to 4 microamperes; d.c. voltages of 0 to 10, 100, 250, 1000, 5000 volts; in addition to the usual resistance and decibel ranges. Employs square 3 inch type meter with 200 microampere movement and sensitivity of 5000 ohms-per-volt. Price \$17.95. Radio City Products Co., Inc., 88 Park Place, New York, N. Y.

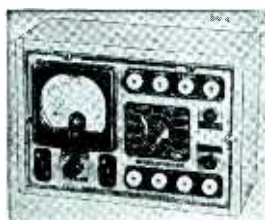

SIMPSON

AMMETER—Compact instrument, model 280, provides readings on five different ranges from a fraction of an ampere up to 25 amps. Includes built-in transformer. Measures 2 7/8 by 5 1/4 by 1 3/4 inches. This unit one of a series of companion testing instruments. Price \$9.75. Simpson Electric Co., 5216 W. Kinzie St., Chicago, Ill.

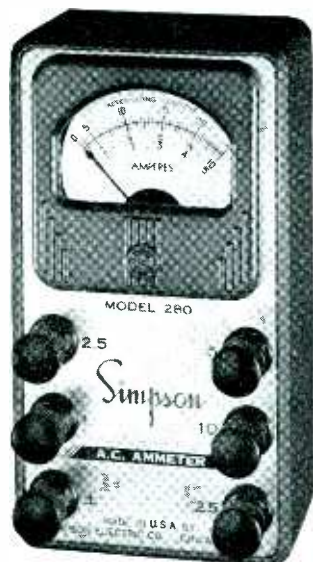

SPRAGUE

CONDENSERS—Three new dual-capacity midget dry-electrolytic type condensers with separate positive and negative leads are added to the Sprague "Atom" series. Intended as replacements for auto radio sets. Types are TU-220, 20-20 mfd. 150 volts, TU-216, 16-16 mfd. 250 volts, TU-88, 8-8-mfd. 450 volts. Last lists \$1.35. Sprague Products Company, N. Adams, Mass.

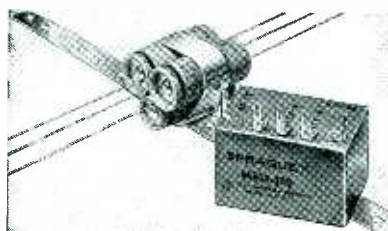

PAGE 44



PARRIS-DUNN

WIND GENERATORS—Announce a complete line of 6, 12, 32 and 110-volt wind-electric equipment. Range from small 135 watt 6-volt to 2500 watt in both 32 and 110 volt units. Charger illustrated is 32-volt, 1250 watt direct drive designed to electrify the average farm. Parris-Dunn Corporation, Clarinda, Iowa.

BRACH

ANTENNA KITS—Two aerial kits with automatic iron core self-selecting frequency transformers. Designed for broadcast and low-wave application, also frequency modulation channels. FM12-AR unit is the dipole type and FM6-VR vertical style. Both kits supplied with upper and lower couplers and low-loss transmission line. L. S. Brach Mfg. Corp., Newark, N. J.

RCA

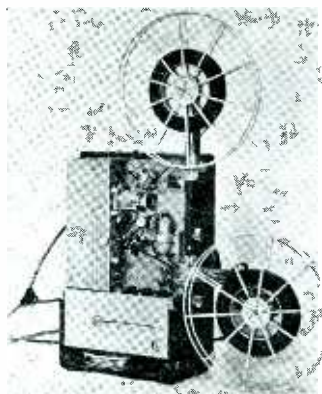

SOUND PROJECTOR—A 16 mm sound projector, for industrial and educational use, is priced at \$300. Model PG-170 has efficient cooling of projection; separate motor for film take-up and re-wind, eliminating the use of exterior belts; is adjustable to provide proper tension for 400, 800, 1200 or 1600-foot reels. RCA Mfg. Co., Camden, N. J.

CORNELL-DUBILIER

DECADE BOXES—Compact capacitor decade units for laboratories and service shops. Series of three available and used in combination provide a range of .0001 to 11.1 mfd. in steps of .0001, or a total of 100,000 different capacitor values. Each switch position is directly calibrated in mfd. Decade box measures 3 7/8 by 5 by 3 inches. Cornell-Dubilier Electric Corp., S. Plainfield, N. J.

AIRTEMP

AIR CONDITIONER—Floor model FC 60 housed in an adjustable grained steel cabinet to fit high or low windows. Cools, dries, cleans and gently circulates the room air. Adds fresh filtered air. Utilizes a 1/2 H.P. motor and a direct-driven 2-cylinder radial compressor. Airtemp Division, Chrysler Corporation, Dayton, Ohio.



SWARTZBAUGH



CONTROL CLOCK—A timer-switch to turn the radio on and off at any pre-determined time. The radio or appliance to be controlled is plugged into the time switch, which has a range of 2 1/2 hours. The device can be used for numerous control applications. Two models available priced at \$5.95 and \$6.95. The Swartzbaugh Mfg. Co., Toledo, Ohio.

PHILCO

CONSERVADOR—Convenient shelf-lined inner door compartment, enabling quick access to small articles; frozen food compartment; reserve storage bin; temperature control; reflector light; quick ice-cube expellers. Philco Radio and Television Corp., Philadelphia, Pa.



RADIO and Television RETAILING, MAY, 1940

Mr. JOBBER!

N.R.P.D.A.

Has an Important

Message for You!

On Thursday, June 13th, 1940 at 7 P.M. at the Stevens Hotel in Chicago, there will be held the First Annual Meeting of the NATIONAL RADIO PARTS DISTRIBUTORS ASSOCIATION.

This will be a Dinner Meeting, for NRPDA Members exclusively, immediately after which a Business Meeting will be held. Complete reports will be rendered by your Officers. A feature of this meeting will be an Open Forum which will afford Members the opportunity to express their opinions on the major issues facing our Industry.

You cannot afford to be absent from this important meeting. Use the coupon below and mail it at once to N.R.P.D.A., 5 West 86th Street, New York, N. Y.

It is up to ALL of us to make this meeting a success. Let us set an example to the entire Radio Industry by showing that we can and will solve our business problems through mutual cooperation.

Since it is essential to make the necessary preparations well ahead of the date of the dinner, only Members making reservations in advance can be admitted to this meeting. It is to your advantage to send your check AT ONCE covering reservations for the number of individuals in your organization who will attend.

NOTICE TO NON-MEMBERS

If you have not yet become a Member of N.R.P.D.A. but plan joining this growing group of influential and far-sighted jobbers at Show Time, we suggest that you send your check covering your dinner reservations and request that we send Application for Membership in N.R.P.D.A. (Only enrolled members may attend this dinner.)

MAIL THIS RESERVATION COUPON NOW

N.R.P.D.A.

Arthur Moss, Executive Secretary
5 West 86th Street, New York, N. Y.

Please reserve places at your Dinner Meeting, Thursday
June 13th, 1940, at 7 P.M. Enclosed is my check for \$
(\$2.50 per person).

NAME OF COMPANY

ADDRESS

CITY STATE

NAME OF INDIVIDUAL

Start planning NOW



TO BE PUBLISHED . . . JUNE 11
CLOSING DATE JUNE 3

- 1 Radio Retailing AD-A-SCOPE, never before featured at any trade show; available *only* to June advertisers; most constructive co-operation ever offered to the industry.
- 2 Industry's largest circulation 25,000 A. B. C.
- 3 Special show distribution guaranteed.
- 4 Outstanding editorial features; assuring maximum reader interest.

Please note closing date above
Your early space reservation will be helpful

RADIO and Television RETAILING — A McGRAW-HILL PUBLICATION
 330 West 42nd Street, New York

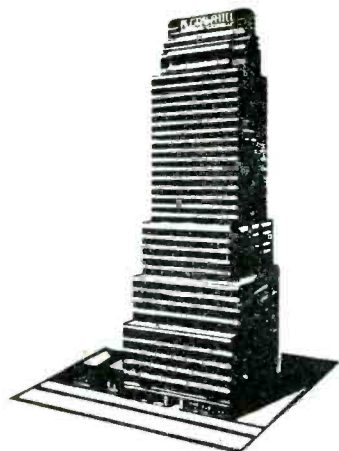

On the Newsfront

June Convention

Schedule of organization meetings

CHICAGO—Listed below are various radio meetings to be held during week June 11-14, when the Sixteenth Annual RMA Convention and National Parts Show will be in progress at the Stevens Hotel, Chicago.

Monday, June 10

Sales Managers Club, Eastern and Western groups, annual joint meeting, 3:00 P.M.

Thursday, June 13

National Radio Parts Distributors Assn. dinner meeting for members, 7:00 P.M.

Friday, June 14

General meeting for members and non-members of National Radio Parts Dist. Assn., 10 A.M.

Radio Parts Manufacturers National Trade Show annual luncheon meeting for member-exhibitors 12:30 P.M.

The "Representatives" annual meeting 10 A.M.

Radio Servicemen of America to open 3rd annual convention.

All Aboard

CHICAGO—The "Radio Industry Special" train carrying radio trade representatives to the Trade Show, is scheduled to leave New York City on Sunday afternoon, June 10th, arriving in Chicago, Monday morning June 11th.

As in previous years, the party will leave the train at Englewood and go to the

Stevens Hotel in a caravan under motorcycle escort. Anyone desiring to join the party on the "Special" should contact Mr. Saftler at 53 Park Place, N. Y. City, phone Rector 2-5334.

Farnsworth Sales Conference

To introduce new receiver line

FORT WAYNE—Farnsworth Television & Radio Corp. has set June 3 and 4 at Edgewater Beach Hotel, Chicago, for its second annual international sales conference. More than 300 representatives from all parts of the United States and several points in the export field are expected to attend.

Introduction of the new line of radio receivers and combinations for the 1940-41 season will be the high point of the conference. Pierre Boucheron, general sales manager, indicated that important announcements will be made at the conference, concerning frequency modulation, home recording and television.

New Quarters

NEW YORK—Dr. Alfred N. Goldsmith, well known technical consultant, announces new location of his office at 580 Fifth Avenue, New York.



PREVIEW F-M RECORD PLAYER
— General Electric radio dealers were recently afforded first hand inspection of the new G-E frequency-modulation wireless record player. Used as a demonstrator

Admiral Convention Dates

Distributors to see line in five cities

CHICAGO—From J. H. Clippinger, vice president of Continental Radio and Television Corp., comes word that distributors will see new Admiral products at conventions in the Edgewater Beach Hotel of this city May 27, in New York and San Francisco June 3 and in Atlanta and Kansas City on June 10.

Elaborate plans are in preparation for all five distribution conventions.

G-E Names Publicity Mgr.

SCHENECTADY—Robert S. Peare, until recently president and general manager of the Maqua Co., a printing and engraving concern affiliated with General Electric, will take over the management of the publicity department of the G-E Company. He succeeds Chester H. Lang, who becomes manager of apparatus sales for the company.

In his new position Peare will also serve as manager of broadcasting, with responsibility for operation of its stations WGY, KGO, and KOA as well as international stations and F-M station W2XOY and television station W2XB.

Stromberg-Carlson Ups C. J. Hunt

ROCHESTER—From the office of Lloyd L. Spencer, general sales manager of the Stromberg-Carlson Tele. Mfg. Co., comes word that Clifford J. Hunt, for 12 years a S-C rep., is now in charge of the distributor division. He succeeds Fred N. Anibal who recently became radio sales manager.



ALL PLEASANT IN JACKSONVILLE — S. N. Shure of Shure Bros. while on a recent trip through the south snapped this photo in front of Radio Parts Company, Jacksonville. That's Shure himself, front, extreme right. Behind him is Raytheon's Earl Dietrich



FRIENDLY RELATIONS — As *Thomas F. Joyce*, RCA's VP. (right) rose to address the Society of Motion Picture Engineers on the outlook for television at their recent convention in Atlantic City, he received a warm greeting from *E. A. Milliford*, president of the Society

Joyce Looks for Green Light

Important role for motion picture industry

ATLANTIC CITY—Thomas F. Joyce, vice-president of the RCA Mfg. Company, recently told 225 members and guests of the Society of Motion Picture Engineers that television was a potentially gigantic industry that would eventually provide employment for hundreds of thousands of people. He predicted

that within twelve months after the FCC grants television stations the right to have commercial television programs, over 25,000 television sets will be sold in the New York Area alone.

About 30 stations in 18 cities throughout the country have applied for tele licenses, Joyce said. Six of these have already been granted. If the others are granted 8 to 10 million families, or about 25 per cent of our entire population will be able to receive television service in the home.

Mr. Joyce invited the motion picture industry to play a more important role in the early development of television as an entertainment service.

Farnsworth Sales Head

FORT WAYNE—E. J. Hendrickson has been appointed sales manager of the Farnsworth division, Farnsworth Television and Radio Corp. I. C. Hunter who has headed the Capehart sales staff for many years, continues as sales manager of this division. Hendrickson brings to his new assignment a wealth of experience in radio and related fields.

Carson New Namco S.M.

NEW YORK—Fred G. Carson, with many years of radio sales experience, both field and executive, has received the appointment of sales manager for The Namco Manufacturing Company.



JOINS CROSLEY — *L. Martin Krauter* just received appointment as advertising and sales promotion manager of The Crosley Corp. He comes direct from the Cramer-Krasselt Adv. agency

Philco Triple Bonus Offer

PHILADELPHIA—Sayre M. Ramsdell, V. P. Philco & Television Corp., announces a new promotion plan to assist dealers in building up higher average unit sales. This new promotion also ushers in two new refrigerator models and supplements its new merchandising tie-up with Birds Eye Frosted Foods.

The feature promotion item is a Philco kitchen radio with built-in Sessions self-starting electric clock offered free with the purchase of any advanced design refrigerator. Purchasers of lower-priced models are given a bonus in the form of a Hammond electric clock housed in a gleaming white case with chrome trim. Third item in the promotion is a crystal glass water chiller given away to each individual visiting a Philco dealer to inspect the new line.

Steckel Joins Bittan

NEW YORK—Ray Steckel, formerly connected with Cornell-Dubilier, is now associated with the D. R. Bittan Sales Co., Inc., 53 Park Place, New York City. Ray is well known in the radio trade.

Mueller Builds

CLEVELAND—The Mueller Electric Company is constructing an addition to its present factory in Cleveland. New plant will have 6000 square feet of floor space. Modern equipment is to be installed for the efficient handling of heavy materials.

It Is Kelvinator

DETROIT — Kelvinator Division of Nash-Kelvinator Corp. calls our attention to an error regarding the illustration on page 38 of the April issue. The refrigerator in the photo was incorrectly labeled Westinghouse and should have been referred to as a Kelvinator. Sorry.

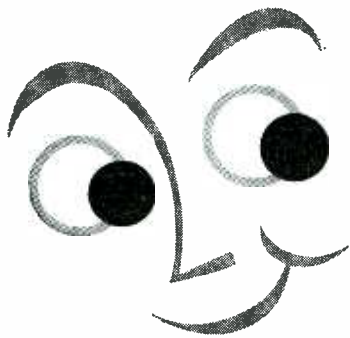

KEEP YOUR EYES OPEN

Look at the Farnsworth line-up from any angle — merchandising plans, product, values, advertising promotion — and you'll see 1940's brightest, eye-opening, profit set-up. For the **BIG MONEY** in radio sales this year, take this tip: *Keep your eye on Farnsworth.*

DON'T CLOSE YOUR EYES TO BIGGER PROFITS

WATCH **FARNSWORTH** FOR '40

DuMont Granted Tele License

PASSAIC—The Federal Communications Commission has just granted Allen B. DuMont Labs, Inc., of Passaic, N. J. a construction permit for a television broadcasting station in New York City. Work has already begun on the transmitter and studios which will be located on the top floor of the 42-story office building at 515 Madison Ave. This is in addition to experimental transmitter W2XVT at Passaic and mobile transmitter W10XKT.



DECADE OF SERVICE — *Charley Golenpaul* and Aerovox are synonymous. Ten years ago he joined Aerovox to build up its jobber sales

RCA Ups Braddock

CAMDEN—Edward Braddock receives appointment as manager of Amateur radio sales for the RCA Mfg. Co., announced L. W. Teegarden of the Radio Tube and Equipment Division. Braddock's new duties will include sale of such products for the radio hobbyist as power tubes, microphones, crystals and transmitting and receiving apparatus.

Morgan, Crosley Market Analyst

CINCINNATI—Duncan J. Morgan has been placed in charge of market analysis for the Crosley Corp. Work will cover market research, sales analysis and industrial trends. Morgan has both a fundamental training and broad experience in this field. He comes to The Crosley Corp. from the American Gas Service of Pittsburgh, where he was head of the market research department.

Parmetal Moves to New Plant

NEW YORK—Parmetal Products Corp. is now quartered in its modern daylight plant, 32-62 49th St., Long Island City. Increased business during the past two years and the forecasting of a good year for 1940 by Mr. Parmet are reasons enough for the required expanded facilities afforded by the new plant.



Have you stopped to THINK what F-M means to YOU?

and have you considered the amazing Profit-Possibilities that are yours with the New Meissner

FREQUENCY MODULATION RECEPTOR

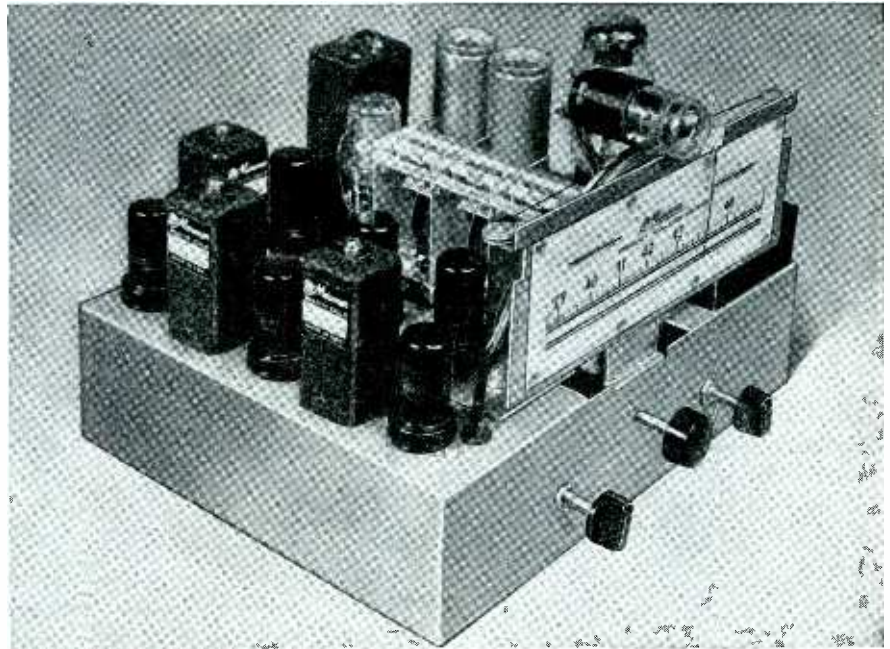

It's easy to figure out—

It certainly doesn't require a lot of mental gymnastics to ascertain the obvious—the fact that Frequency Modulation is here—and here to stay!

The big question is—how soon are YOU going to start cashing in on the increasing demand by the music-loving public for noiseless, static-free reception? The stage is all set—new stations are being built all over the country—commercial licensing isn't far off—AND, the Meissner F-M Receptor is all ready to begin the first act!

Here's an opportunity you must not neglect—the first real chance to get in on the ground floor since the beginning of radio. The Meissner Receptor provides highest quality F-M reception on *any* radio—feeds the audio system of any good receiver. If a separate F-M receiver is desired—just add the simple audio system to the same chassis.

The Receptor is completely wired and tested—all ready to go (except tubes), with complete instructions for adding the audio system. Investigate the F-M possibilities in your territory NOW! See your Jobber at once or write for further details.

INSTRUCTION MANUAL

Get your copy of this big NEW 168-page book, "How to Build Radio Receivers". Contains added material on Frequency Modulation theory and design principles as well as complete instructions on the Receptor. See your Jobber or send 50c at once to the address below. Order it today!

COMPLETE CATALOG FREE

Meissner's entire line of receiver components and complete kits is described and illustrated in this big 48-page catalog. Over 600 items of vital interest to the serviceman and experimenter. Write for your free copy today. A postal card will do!

ADDRESS DEPT. R-5



Quality
in
**PAPER
CONDENSERS**



● For those applications requiring paper type condensers, be sure to check with the new 1940 AEROVOX catalog.



Despite the preponderant use of electrolytics, AEROVOX maintains a wide choice of paper condensers to meet those needs where only paper dielectric can be safely and satisfactorily used. Thus you can have uncased units for your own grouping and container; inexpensive paper tubulars; various types of metal-can jobs; bakelite-case units; oil-filled high-voltage capacitors, etc., etc.



All of which is typical of AEROVOX policy to provide condensers that fit into your exact requirements, rather than expecting you to improvise or warp your requirements to meet an otherwise limited choice of condensers.

**Have You Our
NEW CATALOG?**

● More pages, more items, more choice. Ask your local AEROVOX jobber for a copy—or write us direct. Also ask about a free subscription to the monthly AEROVOX RESEARCH WORKER.



Federal Now In Production

Non-inflammable disc for instantaneous recordings

NEW YORK—The Federal Recorder Company announces completion of first factory unit at Elkhart, Indiana. Said to be the newest and most modern disc plant in the country.

Delivery of the first disc began April 22, and production will be rapidly speeded up until this unit's capacity is reached. As demand requires, production can be stepped up to 250,000 units per week.

The new disc as described by Max M. Pochapin, president of the company is a non-inflammable special metal base, made in sizes 6½, 8, 10, 11 and 12 inches. The plant is situated on the factory site of C. G. Conn Ltd., manufacturers of band instruments and majority stockholder in the Federal Recorder Co.

Sales Rep. For Chicago

PASSAIC—Allen B. DuMont Labs. appoints Alfred Crossley as its sales and factory representative for the Chicago district. Since 1932 Crossley has been engaged in consulting engineering and sales work. He is former chief engineer of Steinite and Howard Radio companies.

Experienced Servicemen

JACKSON—The first of a series of annual post-graduate courses for experi-



COLUMBIA CONFAB — Will Bradley, Columbia recording maestro, visits Bridgeport headquarters to confer with Pat Dolan, sales promotion director and his staff. Object is to put over a new sales drive on his records

enced radio servicemen is being arranged by Harold Davis under the sponsorship of testing equipment and parts manufacturers.

The course is to be held in Jackson, Mississippi from July 15 to 27 inclusive. No tuition will be charged. The course is for experienced servicemen only and no beginners will be accepted.



KEEP YOUR EARS OPEN

● Keep your ears cocked for the big radio news of 1940 — a profit-packed line by Farnsworth, engineered inside and out, top and bottom, for sheer SELL-ability and profits. Be ready to listen to a story that will mean music for your ears and money in your pockets.

HEAR THE WHOLE PROFIT-STORY FOR YOURSELF

WATCH **FARNSWORTH** FOR '40



TO MANAGE DISTRICT SALES — G. E. DeNike for past 9 years advertising mgr. for National Union Radio Corp. is now in charge of New York state district sales. "Ed," as he is familiarly known, will make his headquarters at Geneva, N. Y.

Hotpoint Launches Campaign

CHICAGO—Started March 25th, to continue for ten weeks, the Hotpoint organization launched a distributor sales campaign with special promotional packages. These packages will include store traffic builders, consumer literature, posters and window displays all to assist distributors and retailers in making the ten weeks Sweepstakes activity the greatest sales stimulator in Hotpoint appliance history.

Books On Review

FREQUENCY MODULATION. By John F. Rider, 136 pages. John F. Rider Publisher, Inc., New York, N. Y. Price \$1.00.

While this new book on frequency modulation was prepared for the serviceman, it will also prove of value to the dealer and general reader.

A broad view of the differences between the two types of transmission and reception, amplitude, and frequency modulation are first presented so the reader can gain a picture of the whole subject and from there on, specific differences are discussed.

A chapter is included on what happens at the transmitter, likewise in the receiver, one on f-m receiving antennas and a final chapter on servicing f-m sets. Servicemen will find these important pages with information on oscillators or signal sources for alignment, interference, signal tracing and other instructive data.

The book with its numerous charts and test hookups should prove a real help to anyone experimenting or working with frequency-modulated receivers or allied equipment.

A C. I. S. E. DISTRIBUTOR WROTE THIS AD

FOR

Clarion

"Your equipment stands up. It was used all last year at the New York World's Fair . . . from 10 A. M. to 2 A. M. the next day, every day in the week . . . I have installed your (Clarion) equipment in Night Clubs, and in Club Rooms and the owners are very well pleased with the performance . . . as well as the ease of operation.

I wish to thank you for the cooperation and advice given to me by your Engineering Department. I wish to thank your Sales Department for the leads they referred to me as well as the advertising material which was furnished free of charge."*

*Name on request.

NO OTHER SOUND EQUIPMENT LINE OFFERS
A PROFIT OPPORTUNITY LIKE THIS!

Here's why this C. I. S. E. distributor wrote to say, 'Thank you'. Profits come easier, bigger, more often to the Clarion Sound representative. Clarion sales increased 100% last year alone! 1940's going to be even bigger. That's because of Clarion's Protected Profit Plan.

This gives you factory purchasing power; exclusive sales territory; free engineering counsel; the services of Clarion's staff and laboratory equipment;

the backing of national advertising together with local sales promotion; the further advantage of live leads.

As our representative, and member of the Clarion Institute of Sound Engineers (no cost) you, too, will be grateful, along with the hundreds of other Clarion distributors for the preferred position you will enjoy in the Sound picture, and the easy, extra profits Clarion helps you bank.

OR A P. A. LINE LIKE THIS

Clarion Sound Equipment has been "individualized". Yes, designed to stand apart from all the rest! First in P. A. to capitalize on product individuality, Clarion smartly scores a *double-play* with a 1940 line of Sound Equipment so original, so distinctive that anyone can "spot" a Clarion installation today.

Prestige for you—more business, too, and extra profits. Get the full facts—at once—on the Clarion Plan and the Clarion line.



ACT NOW!

Only one official Clarion representative to a sales territory. Send for your C. I. S. E. application today.

COMPLETE CLARION LINE WILL BE DISPLAYED AT THE
CHICAGO TRADE SHOW

CLARION INSTITUTE OF SOUND ENGINEERS
TRANSFORMER CORP. OF AMERICA

69 WOOSTER STREET

NEW YORK, N. Y.

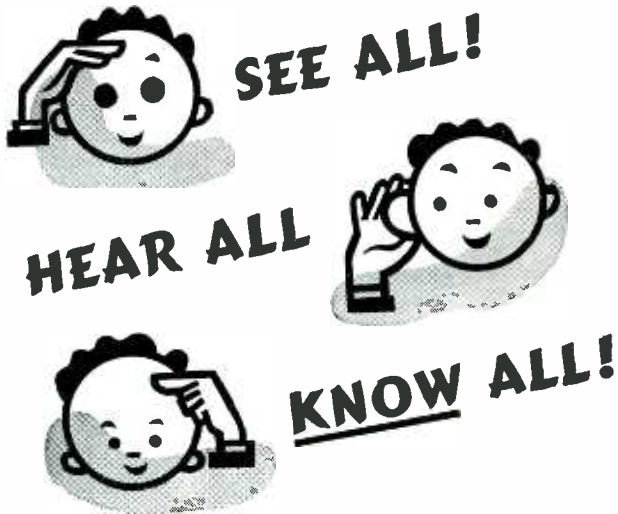

● Step into radio's profit picture by sitting in on Farnsworth's Profit Preview—the dramatic dealer meeting that will make you stand up and cheer. You'll agree it's the biggest Money-making Show of the season. There's a seat waiting for you. See the facts! Hear the facts! Check the facts!

GET THE FACTS ON FARNSWORTH FIRST!

WATCH **FARNSWORTH** FOR '40

This New Series Webster Electric Crystal Pick-up Offers Jobbers MAXIMUM Profits

Many outstanding features, unusual performance, beauty of design, and the reputation of Webster Electric make this new Pick-up a good bet for any jobber. The price is right, and discounts insure real profit for jobber and service man. Write for details—you'll want to read about the features of the NEW Webster Electric Crystal Pick-up.

WEBSTER ELECTRIC COMPANY
RACINE, WISCONSIN, U.S.A. Est. 1909
Export Dept.: 100 Varick Street, New York City. Cable Address: "ARLAB" New York

Licensed under patents of the
Brush Development Company



WITH SONORA CORP. — *Ray E. Shadley* has been appointed controller of Sonora Radio & Television Corporation. Has wealth of experience in the radio field, formerly with General Household Utilities and Grigsby-Grunow

NRPDA Announces New Bulletin

Contains pertinent data for members

NEW YORK—Art Moss, executive secretary of the National Radio Parts Distributors Association presented us with a copy of the new NRPDA house organ entitled "News of the Month." It is the intention of the Association to publish this bulletin monthly and to convey as much unbiased information of value as it is possible to secure.

The following companies from the state of Michigan were recently added to the membership of the NRPDA: Wedemeyer Radio Co., 221 East Liberty St., Ann Arbor. M. N. Duffy & Co., 2335 Grand River, Detroit. Radio Tube Merchandising, 508 Clifford St., Flint. Shand Radio Specialties, 203 N. Kearsley St., Flint, and Toledo Radio Specialties, 217 Loth St., Toledo. Also, Radio Inspection Service, 227 Asylum St., of Hartford, Conn.

As a further step in the development of the Association, a number of sectional meetings were held under the chairmanship of Arthur Moss. A large dinner meeting was held in Philadelphia at the Benjamin Franklin Hotel on April 21st, and on April 23rd, a meeting of the New England jobbers took place in the Hotel Manger, Boston, Mass.

Clarkson with Columbia

NEW YORK—Robert J. Clarkson recently joined the transcription and commercial recording division of the Columbia Recording Corp., according to an announcement by W. A. Schudt, chief of this section. Clarkson will handle sales and client contacts. For the past three years he has been associated with the transcription sales dept. of station WOR.

General Electric Exec. Upped

Lang now manager of apparatus sales

SCHENECTADY—Chester H. Lang, manager of G-E advertising and sales promotion activities since 1932, is now manager of apparatus sales and vice chairman of the company's apparatus sales committee. This field takes in big turbines to tiny motors.

As advertising manager and a member of the above named committees, Lang has been intimately associated with all commercial activities of the company. He organized its market research bureau in 1932, a section devoted to sales analysis of existing and contemplated products. Lang entered the employ of General Electric in 1919 and is well known in the field of advertising, having served for two years as president of the Advertising Federation of America.

Record Library Competition

CAMDEN—Properly housing a record library is every collector's problem. Aware of this fact and in an effort to provide suitable answers, RCA Victor announces awards totaling \$500 in records for the best photographs of home record libraries.

First award is \$100 in records; second \$75 worth of records, third \$25 in records followed by ten awards of a choice of a five-pocket album or five single records and 100 awards of one record each. A good clear snapshot of a handful of prized selections as stored for normal usage will serve. Awards will be made solely on the basis of the picture and the attractiveness of the library itself.

BELDEN'S HERBERT W. CLOUGH — Recently elected vice-president in charge of sales for Belden Manufacturing Company. Eighteen years of service with the company provides him with a broad picture of production and sales



It's Here!

A Multiple Range

A. C. AMMETER

for \$9.75 (Dealer's Net Price)



High Sensitivity Set Tester—MODEL 260

For television and general servicing. Ranges to 5000 volts—both A.C. and D.C. at 20,000 ohms per volt D.C. and 1000 ohms per volt A.C. Resistance readings from 10 megohms down to 1/2 ohm and five Decibel ranges from -10 to +52 D. B.
Dealers net price... \$27.50



An Advanced Signal Generator MODEL 310

Your kind of Signal Generator—designed down to the most minute detail for highest accuracy, greatest stability, minimum leakage and good wave form. Smooth vernier control permits close settings and big 9-inch dial with knife edge pointer assures accurate readings.
Dealers net price... \$37.50

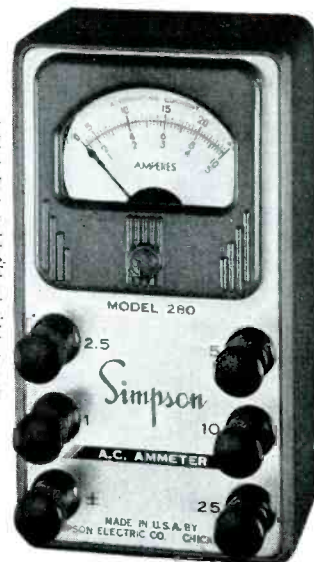

RANGES:
0-1, 0-2.5,
0-5, 0-10
and 0-25
amps.

THE Simpson Model 280 Micro-Tester is the first low priced A. C. ammeter ever offered that combines an indicating instrument with a current transformer—that provides reading in five different ranges from fractions of an ampere up to 25 amperes. It fills a vital need in every service organization, manufacturing plant or laboratory.

Model 280 is the standard bearer of Simpson's brand new line of Micro-Testers. Each one of these instruments reflects Simpson precision in every detail. All of them have the compact form of the No. 280—size only 2 7/8" x 5 1/4" x 1 3/4". Singly, or in combinations, the nine Micro-Testers will cover practically any testing requirement. They include the following:

Model 281—A. C. Voltmeter 0-150, 300, 600 volts.
Your price... \$9.25

Model 282—Ohmmeter 1000, 10,000, 100,000 ohms and 1 and 10 megohms.
Your price... \$9.75

Model 283—D. C. Milliammeter 0-1, 5, 10, 25, 50, 100, 250, 500, 1000 MA.
Your price... \$9.25

Model 284—D. C. Microammeter 0-50, 100, 250, 500, 1000 Microamperes.
Your price... \$9.75

Model 285—D. C. Ammeter 0-1, 2.5, 5, 10, 25 amperes.
Your price... \$9.25

Model 286—A. C. Voltmeter (Rectifier type) 0-5, 10, 25, 50, 100, 250, 500, 1000 volts.
Your price... \$9.75

Model 287—D. C. Voltmeter 0-1, 2.5, 5, 10, 25, 50, 100, 250, 500, 1000 volts. Your price \$9.25

Model 288—A. C. Milliammeter 0-5, 25, 100, 250, 1000 MA.
Your price... \$9.75

Write for the new Micro-Tester Catalog

SIMPSON ELECTRIC CO., 5216-18 Kinzie St., Chicago

SIMPSON

INSTRUMENTS THAT STAY ACCURATE

WHAT'S HAPPENING AT CROSLLEY



● It's playing the sweet music of the cash register. For Farnsworth thinks from the dealer's point of view . . . has worked to put more dealer-profit back into the radio business. You'll find the Farnsworth Line for '40 is sizzling hot in every price bracket . . . highly competitive, profitable, trade-building for your store.

RIDE THE FARNSWORTH ROUTE TO REAL PROFITS

WATCH **FARNSWORTH** FOR '40

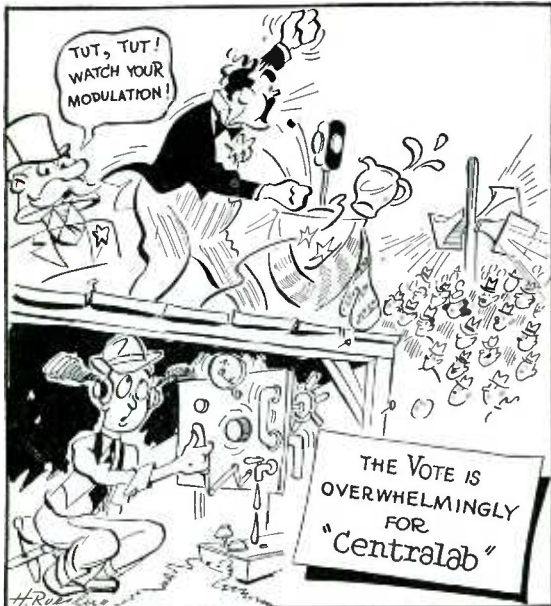

Centralab plays no Favorites

A thoroughly democratic gent is Old Man Centralab . . . for he keeps his "promises" no matter what "system" you use. Whether you are

talking to a handful of listeners or to a frenzied football field . . . Centralab parts stand up under all decible deluges. An overwhelming majority of the boys vote for **CENTRALAB VOLUME CONTROLS — CENTRALAB RESISTORS — CENTRALAB SWITCHES.**

always specify

Centralab

Div. of **GLOBE UNION Inc.**
900 E. Keefe Ave.
Milwaukee, Wisc.

Philco Convenes June 10-13

PHILADELPHIA—Philco Radio & Television Corporation's distributor convention is to be staged at the Edgewater Beach Hotel, Chicago, June 10 to 13 inclusive, will probably begin with a press preview on the night of the 10th.

Over 700 are expected to attend to see new Philco radios and phono-combinations.

Manages Crosley Dist. Corp.

CINCINNATI—Guy Flaig, pioneer in the electrical appliance business both as distributor and manufacturer's representative, has been named manager of the Crosley Distributing Corp. of Cincinnati.

Thomas W. Berger, Crosley's general sales manager, stated that Flaig's appointment is the start of a more aggressive and broader effort to merchandise its products in the company's home city and immediate territory.

Joins U. S. Record

NEW YORK—The United States Record Corp. makers of Royale and Varsity records signs Herbert Shoemaker, veteran record man, as district sales manager of the southwestern territory. Includes Oklahoma, Texas, Nebraska, Colorado, New Mexico, Louisiana and Arkansas.

G-E Promotion Plans

NEW YORK—Key men in General Electric's radio and television departments will, this year, begin a series of regional meetings for distributor principals on the Pacific coast. They will present the new 1941 radio line with plans for its promotion, and will conclude the tour at the headquarters, Bridgeport, Conn.

This reverses the direction of the distributor showings, ordinarily the starting point originated at Bridgeport. Only the heads of distributor organizations and regional managers, district managers and radio field representatives will attend the sessions.

Signs With Tech-Art

TACOMA—James V. Griffith, formerly owner of the Griffith Sales Company of Tacoma, Washington, is now with the Tech-Art Laboratories, 1419 N. Anderson St., Tacoma, and will act as general manager and chief engineer. Tech-Art will devote all activity to the distribution and manufacture of recording, reproducing and communication equipment and supplies.

Re-elects Board

NEW YORK—American Television Corp. announces appointment of Eugene Martin as advertising manager. Also, the re-election of its board of directors which consists of Samuel M. Saltzman, president; Dewey Bullock, vice-president; E. C. Santilli, secretary and treasurer; Dr. Joseph Alexander, Clarence H. Dragert and Raymond W. Starr.

Distribution News

RCA—The Strauss-Frank Company of San Antonio and Houston, Texas, has been appointed distributor for RCA Victor products in the south Texas area. Separate display rooms are being built by Strauss-Frank to show receivers, phono, tubes and records.

MUSICRAFT—Harris Manufacturing Company, of 2422 West Seventh St., Los Angeles, Cal., receives exclusive distributorship for accessories and Duralite products, for the state of California. This company was formerly distributor for Columbia records and in more recent years, the Portophone.

FADA—The Peoples Electrical Supply Co., 347 No. Gay St., Baltimore, Md., are appointed distributors for the Fada Radio products in the Baltimore trading area. They will service customers on a dual basis with the J. R. Hunt Company of this city.

FARNSWORTH—Pierre Boucheron, general sales manager, announces in less than a year, a distributorship of 53 aggressive jobbers. Latest appointments are Charles S. Martin Dist. Co., of Atlanta, with a branch at Athens, Ga. and the Benjamin T. Crump Co., Richmond, Va. Territory for Martin Co. includes approximately the northwest half of Georgia. The assignment to the Crump Co. is the southeast half of Virginia including Norfolk and the eastern third of North Carolina.

GOULD-MOODY—The Vaidaphone Company of Los Angeles, Cal. recently received appointment to handle the G-M recording blanks and other products.

COLUMBIA RECORD—The Flint Dist. Co., Salt Lake City, Utah and Farrar-Brown Co., Portland, Me., two new distributors for Columbia Brunswick and Vocalion records. The Flint Company, 216 W. Second South St., will service clients in the state of Utah, southern portion of Idaho and 5 counties in Nevada. The Farrar-Brown organization located at 492 Forest Ave., will cover the state of Maine and 4 counties in New Hampshire. General Equipment Corp. of Boston handled the above area until the present time.

Dealer Helps

MARINE RADIO FOLDER—Bulletin MR-40 just released by the Harvey-Wells Communications Inc. of Southbridge, Mass., describes this firm's 1940 ship radio-telephone equipment. Space in the folder is devoted to information on rates and licenses. Mention *Radio Retailing*.

RANGE FOLDER—Landers, Frary & Clark, New Britain, Conn., releases a new catalog page on its special priced leader "Meteor" model electric range No. 1140. Outlines features and all specifications.

6 ways to STOP FEEDBACK ... all in ONE mike!

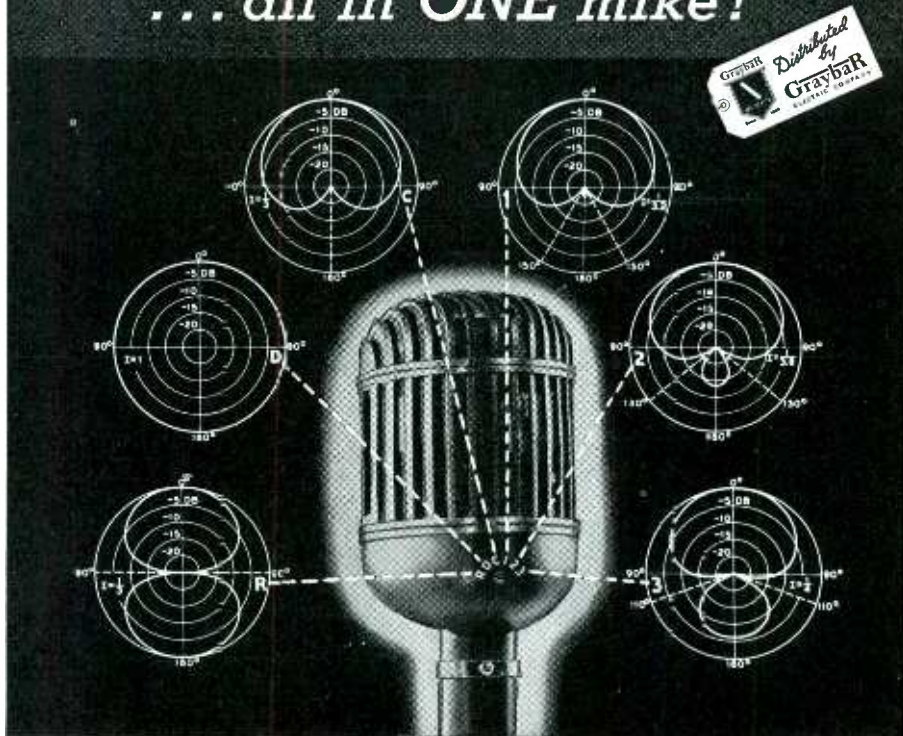

You can tackle any P. A. job with a NEW 639B

Now there's a companion microphone to the 639A Cardioid. It's the Western Electric 639B.

It offers you six patterns at the turn of a switch. Non-directional, bi-directional, and cardioid—plus patterns 1, 2 and 3, which permit you to shift

the angle of minimum response to 150°, 130° and 110°. With these patterns, low frequency reverberation and feedback don't stand a chance!

This mike will be a business builder for you. Get full details. Send the coupon today.

Western Electric

**639 B CARDIOID
DIRECTIONAL MIKE**

GRAYBAR ELECTRIC CO., Graybar Bldg., New York.
Please send full details on Western Electric's new
639B Cardioid Mike. RRR-5-40

NAME

ADDRESS

CITY STATE



DISPLAY CARDS — The *Hotpoint Home Laundry Division*, through its jobbers, makes available to retailers three new easel display cards finished in brilliant red, blue, black and white. The

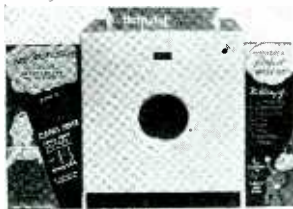

cards form a new window or floor display for the *Hotpoint* tumbler clothes drier. It is part of the Spring "Three Step-Three profit" plan recently announced to retailers.

TEST EQUIPMENT CATALOG—*Radio City Products Co., Inc.*, has a new test equipment catalog, No. 122 listing its complete line of tube and set instruments. Featured is the new universal deluxe multimeter and the model 308 dynoptimum tube checker. Write *Radio City Products Co., Inc.*, 88 Park Place, New York.

TUBE HANDBOOK—New 50 page receiving tube handbook, just published by the *Ken-Rad Tube and Lamp Corp.*, Owensboro, Kentucky. Contains ratings, characteristics and curves on recommended types tubes for new receivers. Of particular interest to set manufacturers, engineers and set designers.

AUTO CONTROL CATALOG—The *F. W. Stewart Mfg. Corp.* of Chicago, Ill., have just issued a 1940 catalog featuring a complete line of auto custom-built remote control accessories. For copy write the above company at 340 Huron Street, Chicago.

AMPLIFIER LITERATURE—*Amplifier Co. of America*, announces two new folders on direct-coupled amplifiers. They describe 10, 20 and 30 watt d.c. amplifiers outlining their electrical and mechanical features. Interested readers write to 17 W. 20th St., New York, N. Y.

HANDY SHOP APRON—*Hygrade Sylvania Corp.* has a new apron for servicemen which lends a neat appearance and at the same time, its two big roomy pockets are wide open to receive screwdrivers and socket wrenches. The apron is made of heavy duck and it costs 25 cents.

AERIAL DISPLAY—Here's a photo of *Galvin Manufacturing Corporation's* aerial display board which permits the demonstration of six *Motorola* Booster

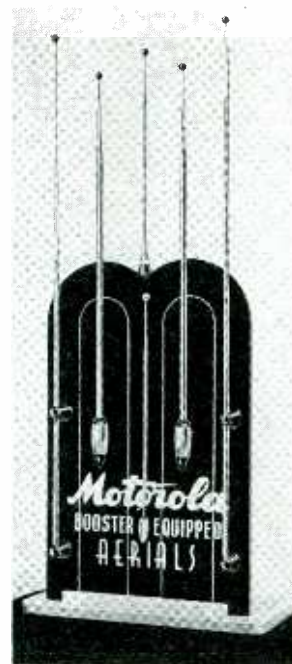

aerials. The size of the board is 25 inches high by 18 wide by 7½ inches deep. Finished in bright colors to attract customer attention.

WINDOW DISPLAY—A new window display featuring a timely tieup with *Pinocchio*, the character of fantasy from the current *Walt Disney* film, is now being distributed to *Sylvania* dealers and servicemen through jobbers. This display is lithographed in eight arresting colors and stands 40 inches high. *Jiminy Cricket*, conscience to *Pinocchio*, advises him to replace with new tubes. Copy at base warns, "Don't Put it off! Replace 'Tired Tubes' with *Sylvania* Set Tested Radio Tubes."

**WHEN THE
POSTMAN
KNOCKS...
OPPORTUNITY
KNOCKS!**



• You wouldn't throw a wad of dollar bills in the waste-basket. So watch your mail closely from now on. It's going to bring you a double opportunity . . . a chance to get all of the profitable *Farnsworth* facts . . . a chance to really go places in '40, and put a wad of money in your bank account.

WATCH **FARNSWORTH** FOR '40



SPEAKER BOOKLET — *John Meck Industries* announces a booklet entitled "How to Match Speaker Systems." Contains instructive data for connecting multi-speaker systems to an amplifier, matching voice coils and other helpful data. Interested readers can write to the above company, Randolph at Elizabeth Sts., Chicago, Ill.

TEST INSTRUMENT BOOK—The *Earl Webber Company*, 4358 W. Roosevelt Rd., Chicago, Ill., has a new 8-page booklet on radio service instruments. Copies are offered free of charge. Mention *Radio Retailing*.

CONVERTER FOLDER — Bulletin No. 13-25 on *Janette* rotary converters has just been released by the *Janette Manufacturing Company*, 556 W. Monroe St., Chicago, Ill. The bulletin lists a complete line of converters for use with radio receivers, amplifiers, phonographs, and public-address equipment. Copies will be sent on request.

AERIAL DEMONSTRATOR — *Philco Radio & Television Corp.* one-minute aerial demonstrator is receiving unusual interest as an effective sales aid. The device contained in a little black box is powered by a small self-contained battery. By pressing a button on the box a terrific amount of static and interference is generated. The customer is then asked to turn the loop aerial on the receiver and thereby eliminate the static and interference completely.

PORTABLES

(Continued from page 21)

of saying "practically unlimited." The usual applications for portables are already familiar but there are numerous other uses for a companion set which fit like the motor-man's glove, for instance—boats, planes, trailers, cabins and sporting events.

The dealer should pay careful attention to battery replacement requirements. In the middle of the '39 summer season, battery replacement demands started to deplete the dealer's stock and many were cleaned out entirely. This market increases each month, with peak demand due to come in the next two months, which is pleasant news for battery manufacturer and dealer alike.

And the sale of portables need not be strictly a spring or summer proposition. They have proven to be a permanent fixture in the radio field and should be thought of as an all-year promotional radio unit. A New York City dealer of no small importance reports that one-quarter of his 1939 portable sales was made during the Christmas holidays.



N. U. SIXTY DAY SPECIAL
Limited May 1 to June 29

only \$12

DEALER DEPOSIT
You receive delivery at once.
Your deposit is rebated on completion of 650 purchase points.

Model 303 P5

Regular Dealer Price \$24.90

DACO TUBE TESTER

Model 303 P5 Features

- Enclosed in Portable Leatherette Case
- Extra Large, Full Vision Meter
- Standard R.M.A. Circuit
- Snap-Switch Control
- Neon Short-Leakage Test
- All Filament Voltages from 1 to 117 Volts
- Provisions for Latest Tube Types
- Spare Sockets for New Types, Preventing Obsolescence
- High Quality Parts Used Throughout
- Complete, Easy Reference Tube Chart
- Ruggedly Constructed Throughout
- Simplified Operation
- Test Pilot Lights
- Tests Ballast Tubes

**SEE YOUR N. U. DISTRIBUTOR OR SEND COUPON
GET IT FREE THE N. U. WAY**

You get this Daco Model 303 P5 Tube Tester by depositing only \$12.00 with your N.U. distributor. By buying N.U. Tubes, Condensers, and Batteries, you earn purchase points and on completion of 650 purchase points in 2 years, your deposit will be rebated.

Join thousands of other N.U. dealers; have the best equipped shop in town. Over 50,000 completed deals in our 10 years of successful operation of this plan.

NATIONAL UNION RADIO CORPORATION

57 State St., Newark, N. J.

National Union Radio Corporation
57 State St., Newark, N. J. RR 540

Please reserve one for me.

Please have your salesman show it to me.

Name

Address

City State

THE SWINGS TO
CROSLEY

FIGURES CAN FOOL YOU

(Continued from page 23)

Store #9, like Store #17, achieves a fair Gross Profit rate, whereas Store #3, like Store #5, seems to push hardest the least profitable departments.

Putting Facts to Work

Like others, you probably think that with increased sales volume your overhead rate will decline. You are perfectly right. Then, why doesn't it pay to push certain products in off season months?

There are several points to consider about such a statement:

1. Volume without profit is meaningless. If the gross profit on any particular line is no greater than the salesman's salaries, advertising cost and servicing necessary to handle such a line, there is nothing left to cover the overhead, no matter how high the volume.

2. A line should not be pushed during its off-season because it would undoubtedly cost too much in sales effort. Consequently, if such efforts were directed toward other seasonal lines, they would

produce a greater volume and a correspondingly greater gross profit return.

3. To force sales of high priced units during an off-season month, you probably have to make price concessions. This means that the already low gross profit on refrigerators will be cut even further. Therefore, is it not more advisable to accept specific product sales as they arise and to direct your efforts to seasonal lines which will respond readily and profitably to such sales efforts?



A DATE THAT'S WORTH DOLLARS TO YOU

● Your Farnsworth distributor will soon be back from the big Farnsworth Radio Convention. He'll have all the advance news about the sensational Farnsworth Line for '40. Get in touch with him. Get all the facts . . . and we are convinced your business judgment will tell you it's

worth going **FARNSWORTH** in '40

CROSLEY
ON THE PROWL!

TELE SALES TIPS

(Continued from page 26)

sales appeal, on the basis of television paying for itself by holding patrons longer. Suggest purchase to clubs and tell them that there already are cases on record where members dropping coins in boxes affixed to such sets each time they witnessed a show have paid for the equipment in short order and even left some "gravy" to swell the treasury. Foster "television parties" among initial purchasers and offer them a few dollars for leads that later result in sales. It is, in fact, particularly important that the dealer keep in close touch with people initially sold as this is probably the most important source of new business.

Closing Methods

Q: When attempting to close a sale, after a prospect is definitely interested, what would you consider the most effective single inducement?

A: In every instance where I have been called in to help a dealer close I have simply harped on the available programs, parading a list of things which have already been televised and talking about events scheduled for coming telecasts. I find that even today's programs, while less impressive than they will be later, are much more impressive than the average consumer assumes them to be. And I think I can safely say without fear of contradiction by any dealer who has so far sold television that programs live up to my dramatization, that present owners would not dispose of their television for any amount of money if they could not replace it.

Paraphrasing a well-known slogan: Ask the man who owns one.

★ ANNOUNCING ★
HOME RECORDING DISC
Walco

HERE IT IS . . . A NON-INFLAMMABLE PROFESSIONAL QUALITY DISC PRICED FOR HOME RECORDERS

Check these entirely NEW features:

1. Non-inflammable thread
2. No surface noise
3. Indefinite shelf-life
4. More than 100 perfect playbacks
5. Cannot injure cutting needles
6. Lowest prices ever offered

PRICES

6 1/2"	5 for 90c
8"	4 for 95c
10"	3 for \$1.00

FOR ADDED PROFITS:—
 Ask about Walco Sapphire Cutting and Playback Needles.



Be ready for this great new industry with the superior Walco Disc.

JOBBERS: Exclusive territories open. Write or wire today for sample disc.

DELIVERIES AVAILABLE IMMEDIATELY

ELECTROVOX CO.

424 MADISON AVE., NEW YORK, N. Y. PLAZA 8-2740

HEY!
 You Ain't Seen Nothin' Yet!

WATCH
 FOR THE RED HOT

Sentinel LINE

TO BE ANNOUNCED IN JUNE ISSUE



NEW! By John F. Rider
THE OSCILLATOR AT WORK
 Get your money's worth—KNOW! This new book tells all about ALL oscillators. It explains the theory by means of simple illustrations, diagrams and curves. It gives you the practical facts you need to combine theory and practice. Get your copy TODAY! 256 pages—illustrated—\$1.50.

THE CATHODE RAY TUBE AT WORK
 By John F. Rider
 This is the most complete and practical book ever written on the subject—the only one prepared especially for the radio serviceman. New applications of the cathode ray tube during the past five years require that servicemen know its operation. 336 pages—over 450 illustrations—\$2.50.

AN HOUR A DAY WITH RIDER BOOKS
 On Resonance and Alignment—On Automatic Volume Control—On D-C Voltage Distribution in Radio Receivers—On Alternating Currents in Radio Receivers. 60c each.

JOHN F. RIDER PUBLISHER, Inc.
 404 Fourth Avenue, New York City

Export Div.: Rocke-Int. Elec. Corp., 100 Varick St., N. Y. C. Cable: ARLAB

Read RIDER BOOKS
 BANISH BEWILDERMENT—INCREASE PROFITS

YOU don't need to gaze into a crystal globe—just look around you. Television—radio fascimile—electronics in industry; these and other developments are crystallizing right under your very nose TODAY. Here lies the future of the servicing industry—here lies YOUR future in radio. . . . IF you are ready to capitalize. Know as much about these developments as you know about a superhet—OR ELSE see the most profitable part of your business go to a competitor. Read carefully the contents of the following books—and ORDER TODAY!

SERVICING BY SIGNAL TRACING
 By John F. Rider

Use the system of servicing which is proved and endorsed—fastest—most modern—the system you can apply to all receivers regardless of age type or make. Servicing by Signal Tracing operates independently of every limiting factor heretofore encountered. In this new book you learn how all receivers are brought to a common servicing level. You learn how components receive a functional check while the circuits are in an operative condition. Over 360 pages—hard covers—only \$2.00.

SERVICING SUPERHETERODYNES—Changes, changes, changes! That has been the history of the superheterodyne circuit. Make repairs quickly by analyzing the different parts of the circuit quickly. Rider shows you how. 288 pages—profusely illustrated—price \$1.00.



PINCOR

DYNAMOTORS

Governmental and commercial radio engineers all agree that Pincor Dynamotors take the grief out of "B" power supply problems. They are built properly to give thousands of hours of smooth, quiet, dependable operation under all conditions. Types and capacities to meet any requirements for aircraft, marine and broadcast service, police units, sound systems, auto radios, etc. 5 to 850 watts. Input, 6 to 110 volts; output, up to 1750 volts. Mail coupon for complete information.

PIONEER GEN-E-MOTOR CORPORATION
 Chicago, Ill.
 Export Address: 25 Warren St., N. Y., N. Y.
 Cable: Simontrice. New York



PIONEER GEN-E-MOTOR CORPORATION
 Dept. R-1E, 466 W. Superior St., Chicago, Ill.
 Please send information on Pincor Dynamotors, Motor Generators and special power supply units.

Name
 Address
 City State
 Also send me Rotary Converter Catalog.

* Step Out

to the **TRADE SHOW**
and step up your profits

June 11, 12, 13, 14

Stevens Hotel, Chicago



You have to be alert these days to get the business and reap the profits . . . You have to be right up to date on all activities of your industry . . . You have to look ahead and be prepared to take full advantage of the new trends in products and merchandising plans.

That's why you should be at the Trade Show. That's where you will get the "low-down" on what's ahead . . . That's where you will meet with hundreds of others and get ideas that are vital to the successful operation of your business.

Step Out to the Trade Show and Step Up Your Profits!

JOBBER DAYS

Tues., Wed., Thurs., June 11, 12, 13

*Open on these days to Jobbers,
Manufacturers, Manufacturers' Agents, and
Manufacturers' Engineers*

OPEN HOUSE

Friday, June 14

*Trade Show open on this day to entire
Radio Trade*

Radio Parts National Trade Show

Sponsored by Radio Manufacturers Association and Sales Managers Club

Executive Office • 53 WEST JACKSON BOULEVARD • CHICAGO

for the Service Department

F-M Wireless Record Player

For use in conjunction with high-fidelity frequency-modulated receivers, the Model JM-31 record player by G-E is similar to conventional wireless record players except that it works on the frequency-modulated principle.

As can be seen from the schematic the 6SK7 serves as the oscillator, generating frequencies in the range from 41 to 44 mc. The oscillator coil, which controls the frequency of oscillation is permeability tuned, resulting in a low capacity circuit.

Shunting the grid end of the oscillator coil is the plate circuit of the 1853 modulator. The characteristics of this tube and its accompanying circuit are such that changes in grid voltage cause corresponding changes in the inductive reactance of the plate circuit. The action is identical to the control tube in an a.f.c. receiver. Since the plate is in parallel with the oscillator tuned circuit, these changes in inductive reactance cause corresponding changes in frequency of the oscillator; in other words, frequency-modulate the oscillator.

Up to this point the oscillator and modulator are identical with standard a.f.c. practice except that the frequency used is considerably higher. The main difference between this circuit and a.f.c. is that the discriminator, which normally generates voltage for operation of the control tube, is lacking. In its place is the crystal pickup. Thus, for variations in a record groove, a corresponding voltage is generated by the pickup in the conventional manner. This fluctuating voltage varies the bias on the grid of the modulator, consequently it varies

the plate current of the tube and therefore the inductive reactance of the plate circuit. This in turn causes the oscillator frequency to fluctuate correspondingly.

To operate the unit, the only connection necessary is to the power line. The signal generated by the record player will be heard on any local f-m receiver tuning to the proper frequency. If a whistle or beat note is heard when tuned in on the receiver, shift the frequency of the record player slightly. It should be remembered when adjusting the unit that the capacity of the hand when placed on the cabinet will often detune the transmitter somewhat.

Voltage-Addition Power Supply

While most of us are familiar with voltage-doubler supplies, few of us have had the opportunity to inspect a voltage-addition circuit as printed herewith from the Mallory-Yaxley Encyclopedia Supplement 6.

With the introduction of high voltage heater type rectifier and output tubes as well as a complete line of .15 ampere heater types, it has been possible to design receivers that do not require an excessive amount of series dropping resistance to operate directly across the power line. Insulation, and consequently voltage breakdown between heaters and cathodes has been increased recently, especially in rectifier and output tubes, so that they will now withstand a B potential of several hundred volts.

Because of this it is now possible

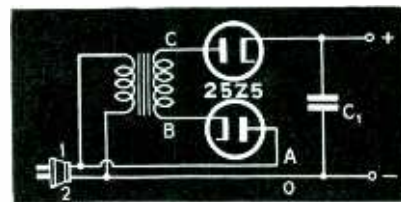

to construct an economical power system in which the heater power has been removed from the secondary of the power transformer and placed on the line side. In addition to this it is only necessary to provide a portion of the B power from the transformer, since by voltage addition, the power line may be used with one rectifier tube to supply a portion of the B voltage. This is shown in the illustration.

Operation is as follows: For the half cycle when terminal 1 is positive there appears a line voltage peak between 0 and A in series with a voltage between points B and C. Since at this instance both rectifiers are conductive the filter condensers receive a charge equal to the sum of the 2 voltages. Assuming the voltages to be equal it becomes obvious that the power transformer need only be half of what is normally needed for a given voltage. In this way a fairly high voltage supply can be built with a small compact transformer.

Simplified C-R Designations

So as to more definitely specify the screen characteristics of cathode-ray tubes, DuMont have modified their tube type designations. These changes involve no electrical or mechanical alteration of the tube, but have been made solely to facilitate identification.

A letter is now contained in the tube number: A indicates medium-persistence green screen; B, long persistence green; C, short persistence blue; and D, medium persistence white.

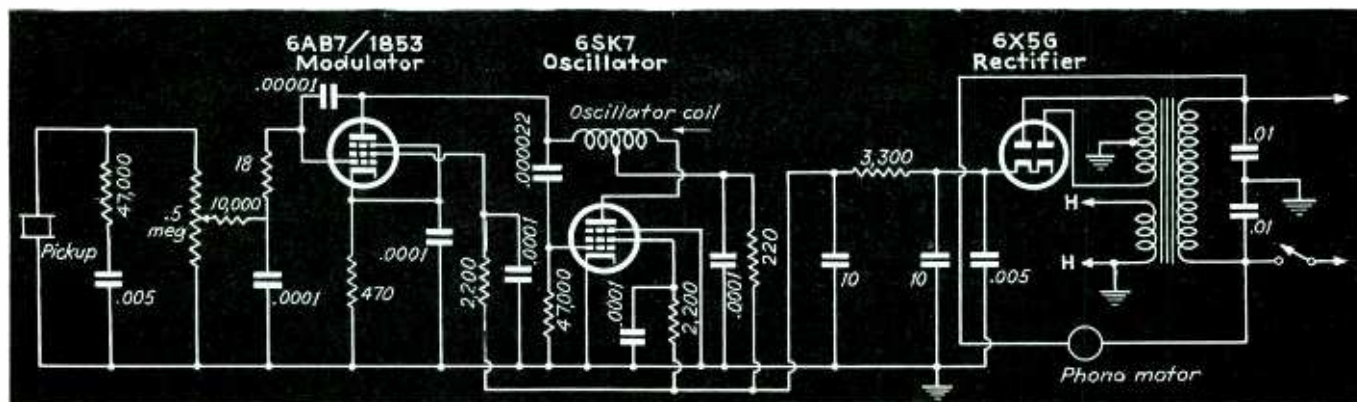

Series Filament Considerations

The universal demand for a.c.-d.c.-battery portables has resulted in many unusual circuit requirements, among them the filament circuit shown here from Admiral's Model F5.

For battery operation, all filaments are parallel and operate from 1.4 volts. When switched to a.c. a series circuit results, requiring 7 volts for operation.

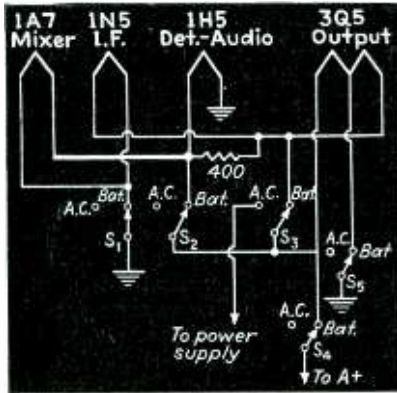

In the a.c. position all the filaments are at different potentials since the voltage drop in each tube puts each preceding tube that much above ground. As there are no cathodes in these tubes, the potential above

ground of each filament becomes a bias voltage if the grid returns are made to ground. This is particularly important in the a.v.c. network since at least 2 tubes must have approximately the same potential above ground at the filament circuit otherwise the controlled tube receives an initial bias, plus or minus the a.v.c. voltage.

In this particular circuit this is accomplished by connecting the detector—a.v.c. stage and the mixer in series with each other as shown by the heavy line. This puts one side of each filament at the same potential above ground and permits normal a.v.c. action. The i.f. tube could be controlled in a similar manner but both mixer and r.f. could not be controlled at the same time since it would be impossible to have a series circuit and have three filaments returning to the same point.

Two-Band Loop

Permitting reception on short waves as well as broadcast, model 03-5R and 07-5R by Stewart-Warner uses a tapped input circuit.

On the broadcast band, the entire loop is resonated by C1, the tuning condenser, and the padders across each side of the loop tap. When switched

to short waves the switch at the right shorts out the lower section of the loop raising the resonant frequency of the tuned circuit.

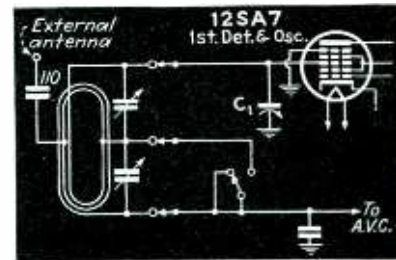

Since antenna pickup will be less on the short wave position, an external antenna may be connected when distance is desired. This may also be used on the broadcast band.

Simple Tone Circuit

Motorola's Model 700 auto receiver contains a simplified tone circuit which gives good tone action.

Connected in the plate circuit of the first audio stage is a 2200 ohm resistance in series with a .03 mfd condenser and a 22,000 ohm resistance. For bass response a s.p.d.t. switch connects the first 2 components mentioned to ground. Since the 2200 ohm resistance is comparatively small, the



**YOU'LL HITCH
ONTO SUCCESS WHEN YOU
HITCH ONTO
CLARION
RADIO**



WARWICK MFG. CORPORATION
1700 W. WASHINGTON BLVD. CHICAGO



**SUMMER
SALES
BUILDER**
List **\$1.95**

large discounts
distributorships
open

a **GENERAL**
"lifetime"
product

GENERAL RECORDS 1600 Broadway
New York City

**A GOOD NAME
GOES A LONG WAY**

Ken-Rad makes dependable tubes—the top-performing tubes that every radio user wants. Specify Ken-Rad on your next order.

Ken-Rad Tube & Lamp Corp.
Owensboro, Ky.

KEN-RAD
DEPENDABLE RADIO TUBES

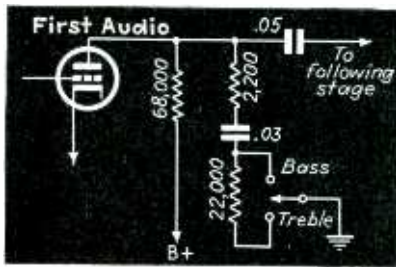

shunting action of the .03 mfd condenser absorbs most of the high frequencies. The use of this resistor is to broaden out the shunt effect.

In the treble position an additional 2200 ohms is inserted between the condenser and ground. This further reduces the shunt action of the condenser and likewise increases the high frequency output of the receiver.

Roto-Base Loop

Two of the new RCA midget models incorporate a built-in turntable in the base so that the set may easily be rotated.

Known as the Roto-Base, it consists of a circular plate on which the entire set pivots. Since the self-contained loop antenna has 2 null points, these may easily be positioned at a point of maximum interference or in between important stations so that reception will not be affected by the null. Whenever a desired station does happen to fall in this null area, the entire set is easily turned to facilitate good reception.



A HANDY SERVICE LIGHT can be made from a defunct pen flashlight by removing the old batteries and soldering 2 flexible leads to the socket. Connect these to an old filament transformer. The whole assembly can be carried in the tool box with no danger of dead batteries when needed.

Dynamic Condenser Tester

Model BQC tester by Solar contains a novel circuit arrangement

which permits checking condensers in an operating circuit. Condensers may be checked separately also.

Basically, as can be seen in the diagram, the unit consists of a balanced oscillator, a tuning eye indicator, and a power source. Operation is as follows: With the power switch closed, voltage is applied to all tubes. The 6J5 in a balanced (more commonly known as neutralized) circuit does not oscillate until the test leads are shorted together or connected across a condenser. This external connection throws the oscillator out of balance and permits it to oscillate. The more it is thrown off balance, the greater the oscillation, consequently a greater amount of rectified grid voltage is developed across the oscillator grid lead R1.

The oscillator circuit forms the heart of the tester in that it is the

control device. Coils L_1 , L_2 , and L are wound on the same form so as to be mutually coupled to each other. Coil L_2 is the grid coil which would normally couple to L_1 , the plate coil, in a conventional oscillator. In this case however, there is little coupling directly between the two. The energy that flows between L_2 and L must pass through L_1 since L_2 couples to L_1 and with the test prods open a neutralized or balanced state exists. When the prods are shunted by a circuit, the coupling between L_2 and L is varied by the change in the circuit of L_1 and the resultant feedback cause the 6J5GT to oscillate.

By throwing switch S_1 - S_2 the oscillator circuit is cut out and a Wein bridge connected to the tuning indicator. By adjusting the control R_2 , capacity measurements from 10 mmf to 75 mfd can be made.

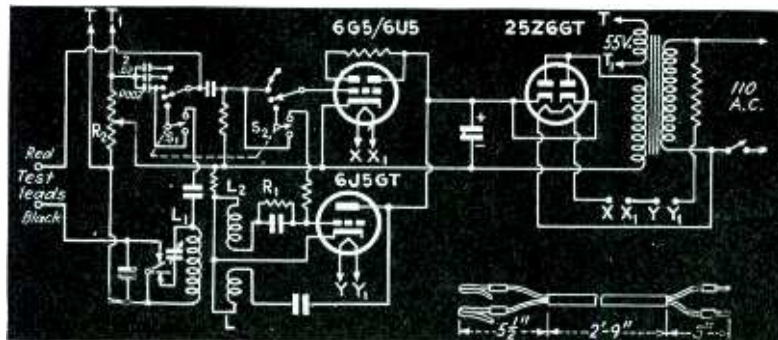

It pays to try Sprague for any exact duplicate condenser requirement. As leading suppliers to the largest set makers, we can supply almost any needed unit promptly—and identical to the original specifications.

But don't forget, you can save on most hard-to-get replacements, simply by combining several Sprague Atom midget dries. Just strap 'em together (see picture) with Sprague ST Mounting Straps—supplied free—and you have a smaller, better unit and actually at less cost than an exact duplicate! Using ST Straps, you can make up almost any combination of capacities and voltages using standard Sprague Atoms stocked by every Sprague jobber. Big new catalog of Sprague Condensers and Koolohm Resistors FREE.

NEW MANUAL ON RADIO INTERFERENCE

Just the book you've been looking for. Complete—fully illustrated—tells what to do, how to do it to eliminate all types of man-made radio noise. 25¢ net.



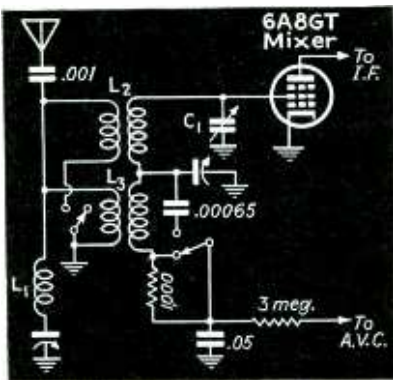

Simplified Bandswitch System

Model DMI-331 by Emerson uses a novel system for switching from the broadcast band to police frequencies. The mixer input circuit is shown here, the oscillator circuit is compensated for this frequency change by tapping the coil and shorting out a portion thereof.

As illustrated, the circuit is switched to the broadcast position. On this range, the bottom sections of the antenna coil only, couples the antenna to the secondary winding. The entire secondary is tuned by one section of the gang condenser C_1 . The grid return end of the coil is bypassed to ground by the .05 mfd a.v.c. filter condenser.

When switched to the police band the antenna windings are paralleled, whereas the lower section of the secondary is effectively bypassed to ground through the .00065 condenser. The 1000 ohm resistor however still permits the a.v.c. voltage to flow to the grid of the 6A8GT and at the same time eliminates a resonance effect in the shorted out windings. C_1 then tunes only the upper half of the secondary.

The inductance L_1 in the antenna circuit and the accompanying condenser serves as a wave trap.

3A8GT—Battery bantam diode-triode pentode by Sylvania. Has 0.1 amp. filament when used on 1.4 volts; draws .05 on 2.8 volts.

3Q5GT—Battery bantam tetrode by Sylvania with series filament. Provides 270 milliwatts of audio power.

6AL6G—Designed as a television amplifier by Raytheon. Similar to a 6L6G but with plate lead brought out the top to allow high momentary peak voltages.

7H7—A high mutual conductance pentode by Raytheon with a 2 watt cathode in place of normal 3 watt cathodes in other high gain tubes. Useful for untuned r.f. stages and wide band high frequency amplifiers. Characteristics are:

Heater Voltage.....	6.3 volts
Heater Current.....	.3 amp.
Plate Voltage.....	250 volts
Screen Voltage.....	150 volts
Grid Voltage.....	-2.5 volts
Plate Resistance.....	.1 megohm
Transconductance.....	3500 umhos
Plate Current.....	.90 ma.
Screen Current.....	2.5 ma.

New Tube Data

1D8GT—A battery bantam diode-triode-pentode by Raytheon for use as a detector, audio amplifier and power output stage. Characteristics are:

Filament Voltage.....	1.4 volts
Filament Current.....	0.1 amp.
Pentode Plate Voltage.....	.90 volts
Pentode Screen Voltage.....	.90 volts
Triode Plate Voltage.....	.90 volts
Pentode Power Output.....	200 mw.

1G4GT—Battery bantam triode by Sylvania for general purpose use.

25D8GT—Diode triode pentode by Sylvania for use in a.c.-d.c. receivers. Filament current is .15 amp.

NO "B" BATTERIES

A combination
Portable
Auto Radio
Home Radio

- Portable . . . Operates on self-contained flash light cells only—(5 or 10).
- Efficient Auto Radio . . . Operates from car battery. Disappearing clips for instant window mounting. No additional antenna necessary.
- "AC" or "DC" for home, office, hotel, etc.



Model "66"

Size—13"x6"x5 1/4"—Wt. 9 1/2 lbs.

A sensitive, selective 5 tube superheterodyne with 3-gang tuning condenser and R. F. Stage. Uses ordinary flashlight batteries obtainable anywhere. No "B" batteries, thus eliminating the usual expensive packs.

Write or wire for full particulars.

SETCHELL CARLSON, INC.,

2233 UNIVERSITY AVE.
ST. PAUL, MINN.

Export Dept: HARRY J. SCHEEL, 330 S. WELLS ST., CHICAGO, ILL. . . . Cable Address "AIRVOICE"

Servicing F-M RECEIVERS

ANTENNA TYPES, transmission lines, installation, alignment methods and other data for the serviceman

By DANA A. GRIFFIN*

AS frequency modulation makes its bow to increasing audiences, as more FM broadcasters come on the air, servicemen will encounter a new set of problems that the new art creates. The first problem is to make sure that a satisfactory demonstration can be made in the salesroom. The next, to be sure that the installation in the customers' home is equally satisfactory. The last is to acquire sufficient knowledge to quickly and accurately service any FM receivers that may require attention.

Good Antenna Needed

The first two problems are rather easily solved by the erection of an antenna system designed for the FM band. Servicemen who think they can toss a few feet of wire on the floor and connect it to the FM tuner, (a popular method on the present broadcast band) are due for a rude disappointment. In the not too distant future when 50 kilowatt FM transmitters come on this may be possible. However, at the present time most of the FM transmitters are running only one or two kilowatts and many are in temporary locations that are not too well suited for ultra-high frequency broadcasting. Until this picture changes, those that want to cash in on the new art will have to take the

* Communication Measurement Labs.

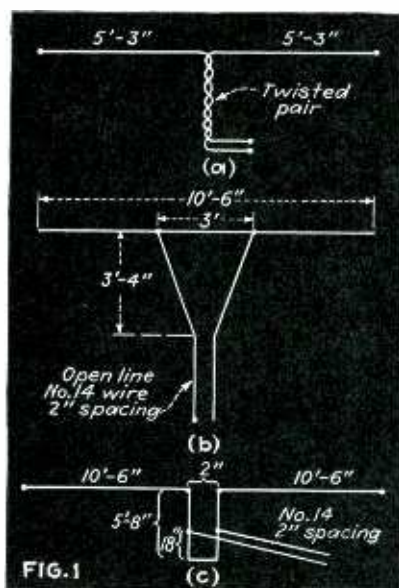

Fig. 1—Three antenna types suitable for F-M reception



Fig. 2—Block diagram of F-M receiver showing necessary connection points to facilitate i.f. alignment

trouble to put up a good antenna system.

The reason a good antenna is necessary becomes apparent when the FM receiver is turned on with no antenna connection. A hissing noise is heard that is not compatible with high quality. This noise is caused primarily by the broad pass band of the i.f. amplifier, together with some other factors that do not fall within the scope of this article. This hissing characteristic can be completely overcome, and the relative silence for which the FM system is noted can be obtained, when the limiter tube in the receiver is properly loaded. This is taken care of by plenty of signal input to the receiver, thus building up a substantial voltage at the limiter. The best way to secure a good signal input level from fairly distant ultra high frequency stations is to put up the necessary antenna.

The higher the antenna the better, is one rule to remember. The losses in even a long feed line will be cancelled by the added signal input obtained by an antenna high in the air. Three simple but effective types of antennas are shown in Fig. 1. The first, in Fig. 1-A, is a dipole center fed with twisted-pair. This antenna may be used where more efficient systems cannot be installed. Despite low cost and ease of installation; twisted-pair feed lines over 25 feet long is not ordinarily desirable. Even co-axial cable in normal sizes has relatively high losses at 42 megacycles.

Feeder System

Inasmuch as we are not particularly interested in the noise reduction properties of the feed line where FM reception is concerned, the open wire line is a good bet. When properly installed the losses are low and this in turn makes certain that we will get the maximum amount of signal input to the receiver from a given antenna. In Fig. 1-B we again find the dipole antenna, but this time it is connected

by a delta matching section to an open wire line spaced two inches with polystyrene spreaders. Naturally it is not always practical to run such a line inside the house. The open wire line can be terminated at the window with lead in strips. To finish the job take two suitably covered #18 solid wires and make up a "twisted pair" from the window to the receiver with as few twists as possible. Of course if the wires can be spaced as they run

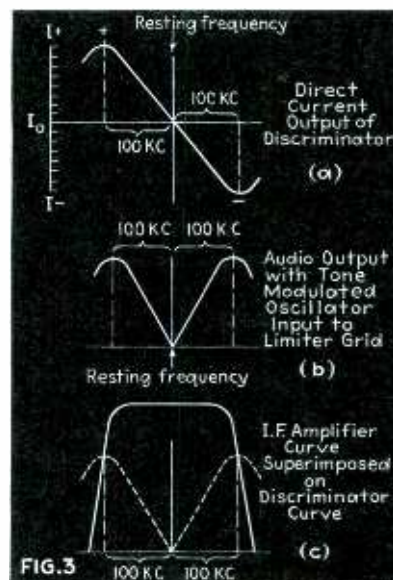

Fig. 3—Alignment curves obtained when plotted from an output meter as the signal generator is varied

around the moulding or baseboard so much the better.

The antenna in Fig. 1-C is recommended for still better results, as an appreciable gain in signal strength is obtained with it in comparison to the single dipole. This system, two half waves in phase, consists of two dipoles properly phased by a matching section between them. This quarter wave section also serves as the impedance matching transformer to connect to the line. In actual practice,

Hit your stride
WITH THIS NEW RCP
MASTER MULTI TESTER

MODEL
No. 414
\$21.95

YOU'LL forge ahead faster and profit more with RCP's sensational new Master Multi-Purpose Model 414. It's a tester like no other! New in design, more comprehensive in performance—with a flock of new features that open up profit possibilities you never hoped to find in one instrument—and certainly never expected in such a high quality instrument priced so amazingly low!

If you're not going ahead fast enough . . . if you've the time for new business and a yen for more profits, here's the instrument to help you hit your real stride.

Features Like These Mean More Business!

5 individual ranges permit capacity measurements from .0001 to 300.0 MFD., or a 3 million to 1 ratio. Ratio of ohmmeter measurements—three hundred million to 1! Center of low ohm scale only 2 ohms with each of 1st ten divisions reading 0.05 ohm. 5 individual ohmmeter ranges up to 15 megohms. 10 AC-DC voltage ranges up to 5,000 volts; 7 current ranges up to 25 amperes. AC rectifier not subject to the frequency, temperature and wave form errors typical with copper oxide rectifier.

Total of 42 individual ranges including output meter, inductance, d.b., capacity, volts, current
Model 414 Bench model with 4 1/2" meter. \$21.95
Model 414 Series VP9 with 9" meter. \$32.95
Model 414P—portable. \$24.50

Write for catalog

and here's another
MODEL 308
SERIES D

RCP Test Instrument — Sales Promoter (Model 308—Series D) — that's everything the name implies. Business-like from its extra-large 9 inch Jumbo Meter to the speed and ease with which it tests. Tests all the new miniature tubes, has spare sockets for NEW developments to come. Compare Model 308D with similar instruments selling for more.

It's a buy, and a money-maker! Counter Model 308 Series D—Net. \$25.95



Combination counter portable model 308P Series D—Net. \$28.85

There's a money-making RCP Test Instrument for every test equipment purpose, and for every serviceman's purse.

If your jobber doesn't have these RCP instruments, send for FREE Catalog No. 122.



RADIO CITY
PRODUCTS CO. INC.
88 PARK PLACE, N. Y. C.

space permitting, this antenna is very easy to construct as the dipoles and matching section can be made from one continuous piece of wire, to which the line is attached. The last point to consider is the fact that all horizontal antennas have some directional properties. It is best to orient those described so that they are broadside to the weakest station from which reception is desired.

FM Service

With the initial installation thus satisfactorily taken care of, the serviceman's FM problems are over unless breakdowns occur. Naturally the FM receiver responds to point to point tests for voltage, shorts, and continuity as does its AM counterpart. Tubes too can readily be checked in the conventional manner.

Alignment is the place where the serviceman will have trouble, unless instructions are carefully followed. There seems to be no way in which the manufacturer can prevent the serviceman from getting himself in trouble with at least his first FM service job. In fact many cannot resist the urge to "Peak Up" the demonstrator with a few deft touches of the screwdriver without reading the instructions. The results are pretty awful to say the least, because the FM receiver cannot be aligned in the conventional manner.

This final problem of the serviceman can however be solved in a very simple manner without the use of expensive equipment if the FM alignment technique is followed. The methods outlined below are a bit unusual, but nevertheless are very satisfactory.

Referring to the block diagram, (Fig. 2) our alignment must start at the output of the receiver, working back towards the front end. The audio amplifier should of course be checked by the usual methods. Then we are faced with the necessity of properly aligning the discriminator circuit. A discussion of the theory of frequency modulation in outline form is necessary in order that the alignment procedure may be understood. At the FM station when no sound impinges on the microphone, a single carrier frequency of constant amplitude is transmitted. If a 60 cycle tone strikes the mike, the carrier deviates either side of this silent or resting frequency at a rate of 60 cycles. The amount it deviates depends on the audio amplitude. In other words the station converts audio frequency to frequency deviation and the amount of deviation depends on the loudness of the audio signal.

The problem in the receiver is to convert frequency deviation back into the audio amplitude changes that occurred in the studio. The discriminator is the device employed to do this. The broad band i.f. amplifier passes

AUTO-RADIO CONTROLS



★ Clarostat has a standard line of Auto-Radio Controls to service at least 95% of all auto-radios. In addition to required resistance values, tapers, taps, there are: AC Series, with special slotted shaft enclosed in sleeve easily cut, holding center milled shaft in shape; MA Series, with sufficiently long shaft milled on both sides, with sleeve; FAC Series, with slotted shaft inside bushing. All controls available with "Slip Drive"—Code SD.

★ Ask your jobber about these auto-radio controls. Ask for latest Clarostat Service Manual. Or write us direct.

Clarostat Mfg. Co., Inc.
285-7 N. 6th St. Brooklyn, N. Y.



JIM QUAM
Says



I get a real kick out of this column every month. It is a privilege to express an idea so that an entire industry may read it.

It bothers me a little that this column is a one way proposition—some of you might want to talk back and should be given a chance to do it.

Well, an opportunity is coming. We will be at the Chicago Parts Show Space 117, and I hope that a lot of my friends will stop in to do a little of this "talking back." I'll promise to do all the listening and then we'll be "all square."

And even if you just say "Hello," stop in anyway, we'll be glad to see you.

QUAM-NICHOLS CO.
33rd Place & Cottage Grove CHICAGO 1674 Broadway NEW YORK





New
The Library now comprises a revised selection of books culled from leading McGraw-Hill publications in the radio field.

McGraw-Hill RADIO ENGINEERING LIBRARY

— especially selected by radio specialists of McGraw-Hill publications

— to give most complete, dependable coverage of facts needed by all whose fields are grounded on radio fundamentals.

— available at a special price and terms

These books cover circuit phenomena, tube theory, networks, measurements, and other subjects—give specialized treatment of all fields of practical design and application. They are books of recognized position in the literature—books you will refer to and be referred to often. If you are a researcher or experimenter—if your interest in radio is deep-set and based on a real desire to go further in this field—you want these books for the help they give in hundreds of problems throughout the whole field of radio engineering.

5 volumes 3319 pages, 2298 illustrations

1. Eastman's FUNDAMENTALS OF VACUUM TUBES
2. Terman's RADIO ENGINEERING
3. Everitt's COMMUNICATION ENGINEERING
4. Hund's HIGH-FREQUENCY MEASUREMENTS
5. Henney's RADIO ENGINEERING HANDBOOK

Special Low Price and Easy Terms

Bought singly, the five volumes comprising this library would cost you more. Under this offer you save money and, in addition, have the privilege of paying in easy installments beginning with \$2.50, 10 days after receipt of the books, and \$3.00 monthly thereafter. Already these books are recognized as standard works that you are bound to require sooner or later. Take advantage of these convenient terms to add them to your library now.

SEND THIS ON APPROVAL COUPON

McGraw-Hill Book Co., Inc.
330 W. 42nd St., New York, N. Y.

Send me the McGraw-Hill Radio Engineering Library 5 vols. for 10 days' examination on approval. In 10 days I will send \$2.50, plus few cents postage, and \$3.00 monthly till \$23.50 is paid, or return books post-paid. (We pay postage on orders accompanied by remittance of first installment.)

Name

Address

City and State

Position

Company R.R. 5-40

(Books sent on approval in U. S. and Canada only.)

frequencies up to 75 kc. either side of the resting frequency at a substantially constant amplitude. The limiter tube which wipes off high amplitude noise peaks makes sure that the output at the limiter plate circuit has a constant amplitude. The discriminator transformer, of special construction, and two diodes, combine to form the discriminator circuit. As the frequency deviates either side of the resting frequency, the output of the two diodes should look like Figure 3-A. The shape of the curve should be the same on either side of the resting frequency, and the change in amplitude should be linear over the range through which the transmitter will deviate.

While there are alignment methods available that will show this curve, it is possible to use the output meter, hanging it on the output of the audio amplifier. Connect a tone modulated service oscillator to point 4 in the block diagram (limiter input). The frequency of the test oscillator should next be set at the resting frequency. Then as the frequency of the test oscillator is shifted 100 kilocycles either side of the resting frequency, the audio output will look like figure 3-B with proper alignment of the discriminator transformer. The output circuit of this transformer is tuned to set the minimum output point on the proper resting frequency. The input tuning condenser controls the size of the two peaks. In practice the output circuit is first adjusted to give zero output at the resting frequency, then the input circuit is adjusted to secure identical peaks on either side.

Final Adjustment

The final wrinkle in FM alignment is to superimpose the i.f. amplifier output on the limiter as shown in figure 3-C. The FM i.f. channel is a broad band affair approximately 200 kilocycles wide. This is necessary so that the amplitude of the signal reaching the limiter will be constant regardless of the deviation in frequency. While an oscilloscope can be used to indicate overall response, the best alignment method is the slow but accurate stage by stage system. Overall alignment of the i.f. channel is likely to give poor results.

The first step is to remove the discriminator tube from its socket. Next connect the input of the audio amplifier to the high side of the grid resistor in the limiter circuit through a .01 condenser and 10,000 ohms. Connect the oscillator to point 3 by opening the connection from the i.f. transformer to the grid of the last IF tube. Now adjust the trimmers of the last i.f. transformer, so that when the frequency of the test oscillator is slowly shifted either side of the resting frequency, a curve similar in shape but

DEALERS and SERVICEMEN

Cash in Now!
ON
**WARD'S FINEST
AERIAL LINE**

... **ALL THESE FEATURES
AT NO EXTRA COST!!**

- Tri-mount model with extra brackets for Underhood-Alligator-Hinge.
- Uni-Plug Silver to Silver contacts. Fits all Motorola and Bayonet.
- High-Q, low capacity, low loss, water-proofed, non-kink leads.
- Flex-Angle Model-fits all body contours, 16 degree adjustment-Chrysler and Torpedo.
- Time saving installations with Ward's new EZ-IN plug, silver contact.
- The only auto aerial with ceramic stanchions.



● DISPLAY WA78

A new Dealer display by Ward that is a truly efficient silent salesman.

**BE SURE TO SEE WARD AT
THE SHOW IN CHICAGO.
BOOTHS 922-924.**

The
WARD PRODUCTS
Corp.
WARD BUILDING CLEVELAND, OHIO



**11 RANGES
TEST ALL
HOUSEHOLD
APPLIANCES**

TRIPLETT

MODEL 1270

\$29.83

Dealer Net

- Five Wattmeter Scale Ranges 0-20-500-1000-2000-4000 (most essential for the modern electric ranges).
- Four Alternating Current Scale Ranges 0-260 Milliamperes; 0-6.5-13-26 Amperes.
- Two A. C. Voltage Scale Ranges 0-130-260.

Has
RED • DOT
Lifetime
Guaranteed
Instrument

Model 1270 is an advanced electrical circuit analyzer that shows the wattage consumption, amperes and line voltage of all household appliances under actual operating conditions.

Power used by the smallest appliances is checked on an extremely low range of 0-20 watts (fused to prevent damage from accidental overload). Other scale ranges make it possible to test electric refrigerators, washers, radios, irons and other appliances, including ranges operating on 220-volt three-wire system.

Readings are shown on a four-inch square Triplett Electro-dynamometer type instrument with long, easily read scales. It carries the exclusive Triplett RED • DOT Lifetime Guarantee against defects of materials or workmanship. The tester case is metal, 7 $\frac{1}{8}$ " x 6 $\frac{1}{2}$ " x 5 $\frac{1}{8}$ ", with black suede baked enamel finish. Has detachable strap handle. Removable cover has elastic band for carrying leads. . . . Modernistic panel is black with silver markings. For 60 Cycles.

Model 1270, complete with leads for two-wire circuits . . . Dealer Net Price . . . \$29.83. (Special leads available for three-wire circuits.)

Dual-Instrument Appliance Testers

Three other Appliance Testers (Twin-instrument type) also are available. These are for specialized applications. Write for details. Section 205, Harmon Drive, Bluffton, Ohio.

- ★ The New 1940-41 Line of Triplett Test
- ★ Equipment Will be Displayed in Booths
- ★ Nos. 619-621 — Chicago Radio Parts
- ★ Show

TRIPLETT ELECTRICAL INSTRUMENT CO.
Bluffton, Ohio

somewhat broader than that shown in figure 3-C is obtained. Next shift the test oscillator to point 2 disconnecting the i.f. transformer from the tube and resoldering the connection at point 3. The same procedure should be gone through again. The skirts of the i.f. curve will begin to "pull in" at this point and of course the output will increase a good deal. The final test is made by connecting to point 1, the converter grid, resoldering the connection at point 2. The receiver oscillator should be disabled as the alignment of the first i.f. transformer is undertaken. The curve should then resemble that in figure 3-C. Slight variations will not cause any difficulty as only a portion of the output is used. A 10 per cent variation in output through the useful range will not cause any trouble.

This concludes the special alignment instructions for the FM receiver. All of the r.f. circuits are taken care of in the conventional manner and therefore require no comment here. Careful attention to the details outlined above, and a little practice will enable any serviceman to quickly and accurately align the FM receiver so that the customer will get the quiet, high fidelity reception that the FM system affords.

SHORTCUTS

FILINGS IN VOICE COILS may be removed by moving the whole cone back and forth and gently applying the vacuum from a flexible vacuum cleaner hose to the front of the voice coil opening.

A NEAT TELEVISION ADJUSTING TOOL can be made from an old auto radio flexible tuning shaft.

Attach a knob to one end; on the other end solder a spring slightly under $\frac{1}{4}$ inch inside diameter. In operation, slip the spring over the control to be rotated and turn the knob on the end of the shaft. The shaft may be any length over 3 feet so that operation of the control may be had while viewing the screen.

NOT LONG AGO we met an embryo serviceman who tried to figure out the resistance of the American flag by the Color Code.



RADIO HEAVEN—What serviceman wouldn't give his grid-tapping-finger to own a bench like this one at Ideal Radio Service, Buffalo, N. Y. Plenty of drawers and compartments for small parts and all the necessary test equipment. An intercommunicator is built-in to facilitate contact throughout the organization. Below is the auto section catering exclusively to auto radio repair and installation



THIS BRAND-NEW PROFESSIONAL WORKBOOK

FREE

TO RADIO DEALERS AND SERVICEMEN

Just off the presses!

"RADIO SERVICE SHORTCUTS"

Contains accurate answers to 1141 set troubles, new circuits, diagrams, and reference charts

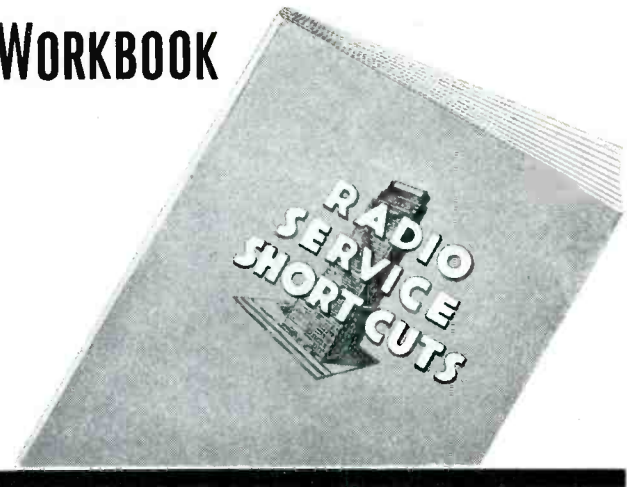

SAVES YOUR TIME! SAVES YOUR MONEY! ENDS SET WORRIES!

HUNDREDS of radio men are using this unequalled, trouble-shooting guide to take the "bugs" out of their toughest repair jobs and pour EXTRA profits into their service work. "Radio Service Shortcuts" is bigger, better, more complete, than the famous "Tricks of the Trade." But it should. It contains not one bit of useless data, no waste descriptions, no theories, no help for fans or amateurs. Every one of its 72 pages is packed with practical, "how to" information that answers the questions on set troubles that crop up in your work every day.

"Radio Service Shortcuts" is one service book that is different. Once you have had a copy you won't part with it for a minute. I know many men who consider it more valuable than their tool kit. This new book contains:

- 1141 tested ways of finding and fixing the troubles common to specific makes and models.

New material on renting and servicing sound equipment repairing phono-combinations handling special features of portable and auto radios.

Valuable reference charts that show you how to handle customers who immediately ask, "What will it cost to fix it?" how to convince buyers that cheap service does not pay how to demonstrate why tubes should be tested at least twice a year how to explain why good service can't be cheap, etc.

● Why are these "tricks" good? Because every one of them came right from the actual experience of professional radio experts. (See typical examples in column to right of page.) Why spend hours of your time testing and re-testing a balky circuit, when, with this new book, you can put your finger on the most probable cause of the trouble in a few seconds.

● These "tricks" will show you how to spot a lot of set troubles that don't show up in any circuit tests you make. If your time is worth money and you like to duck plenty of grief—get yourself a copy of "Radio Service Shortcuts"—today. **IT IS FREE IF YOU ACCEPT THIS OFFER NOW.**

HOW YOU CAN GET THIS VALUABLE BOOK FREE

- Simply fill in and return the order blank below with the subscription fee to cover one year of Radio Retailing for \$1 or three years for the reduced rate of \$2. The brand-new "Radio Service Shortcuts" is included as our gift.
- This book is not for sale separately. Credit orders cannot be accepted. Be sure to enclose remittance with your subscription order. **ACT NOW.** This new work book is going fast. Don't be sorry. Do it today.

Time-Saving Information

Certain radio sets develop trouble peculiar to their particular type of circuit. Each month "Tricks of the Trade" explains how to locate and fix specific set failures. The following are examples of the curt, practical way Radio Retailing offers this vital information to you.

GRUNOW 1191

Dead . . . check .05 mfd. condenser in plate return of second i.f. tube. When this shorts it usually destroys 2000 ohm resistor also.

RCA VICTOR 120

Loud hum . . . isolate green wire coming through hole in chassis and connecting to grid of 217. Try moving this lead in different positions with insulated rod.

STEWART WARNER 112

Vibrator hash . . . inspect vibrator shield can for good contact to case.

If motor noise is extremely bad try shielding the tone control leads and pilot light wires.

STROMBERG CARLSON 60

Oscillation, distortion check grounding of 6B7 shield can. To insure good ground, remove shield base, clean chassis and bolt securely in place.

ZENITH 5905, 5906

Low volume, squeals when volume control is advanced check 8 mfd. condenser (C-21 which is part of No. 22-571) for open.

Fading . . . look for short in trimmer condenser on i.f. stage.

Every issue of Radio Retailing will bring you more of these "Tricks". File them and in a short time with this FREE book you'll have a service manual of unequalled value.

Mail this coupon and payment—Today!

FREE-BOOK SUBSCRIPTION ORDER FORM

PRESENT SUBSCRIBERS NOTICE

Present subscribers may obtain a copy of this FREE book by renewing their present subscription. **Regardless of when your present subscription expires, you must send in another PRE-Paid renewal order.** Your subscription will be extended for additional time without duplication. No previous renewal orders count. We must show a matching order for every book sent out. Mail in your order and payment today.

This offer only applies to U. S. and possessions, Canada, Mexico and Central and South America. All other countries add 50c to foreign rate of \$2 a year to cover postage charges.

O.K. Attached is \$2 for a 3 year subscription to Radio Retailing. With this order I am to get a FREE copy of the 68-page service book—"Radio Service Shortcuts". Send the book at once. Check here if this is renewal order.

Name Position

Street

City State

Our Main Business Is

Check here and remit \$1 if you wish only one year subscription PLUS FREE book.

No orders accepted without payment attached

RADIO RETAILING
330 West 42nd Street
New York, N. Y.

This offer void after Dec. 31, 1940

Pin
— —
\$1 or \$2
Here

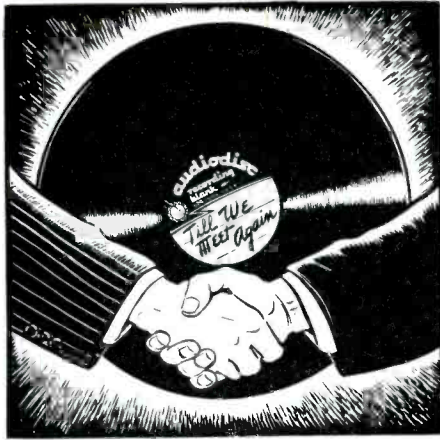

The Creators of

AUDIOLISC

Look forward to meeting you at the RADIO PARTS NATIONAL TRADE SHOW at Chicago (June 11 to 14th) where will be presented a new and complete line of profitable

AUDIO PRODUCTS

"Recording headquarters" at the show will be the display of

AUDIO DEVICES, Inc.
1600 BROADWAY,
NEW YORK CITY
Cable: Audivices New York

RADIART AERIALS
The Line that has EVERYTHING
Get Aerial Catalog 640-B
Vibrator Catalog 5540
THE RADIART CORP.
CLEVELAND

RADIART VIBRATORS

EXACT DUPLICATE
Guaranteed 1 YEAR

T R I C K S

BOSCH 310

Noisy . . . replace 20,000 ohm oscillator grid resistor.

RCA 10T

Lacks sensitivity . . . check cathode bleeder resistor mounted under right side of chassis for increase in resistance. This trouble is usually indicated by an increase in the screen voltage which under normal conditions should be 95 volts.

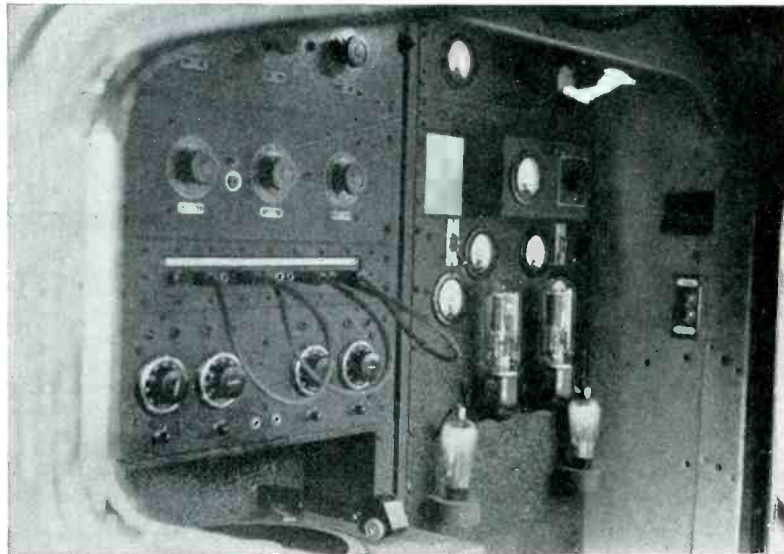

IT GOES IN HERE—Rack sound system inside the truck of Mu Sound, Nashville, Tenn. Turntable and pickup show in the lower left. Mixer, directly above, permits various inputs. Output tubes (right) are 838^o. Power is supplied by 2 kw. gas generator

CROSLLEY 517

Dead on broadcast band . . . suspect band switch, often the internal contacts will break off.

RCA R11

Cuts out, only strong locals heard . . . look for leaky bypass from second detector plate to cathode. Replace with mica unit.

EMERSON X211

Speaker rattle that cannot be eliminated by centering . . . look for loose section of cone rim. Heat from 25L6 dries out cement and cone works loose.

RCA 89

Overloads, blocks on loud audio passages . . . shunt 10 mg. grid resistor (R-9) or 6F5 with 1 meg. resistor.

STEWART-WARNER 111, 115

Tunable hum . . . usually caused by condenser No. 15 opening. When replacing this do not use a wax or tar filled unit as heat from 43 will cause this to run into the gang condenser.

FARNSWORTH AT50

Modulation hum . . . connect a .25 mfd condenser from plate of rectifier to chassis.

STROMBERG CARLSON 430PL

Rattle, similar to speaker cone . . . remove labyrinth and tighten wire screen which covers cut-out at bottom of cabinet.

MONTGOMERY WARD 62-177

Dead . . . check screen resistor of the 6B7 which frequently burns out. Original value is 300,000 ohms 1/2 watt. Replace with 1 watt unit.

WURLITZER 450

Dead . . . look for short between primary and secondary of first i.f. transformer. Remove coil and separate leads.

PHILCO 37-9

Poor tone, all voltages check okeh . . . suspect shorted turns in output transformer.

Simplest

WAY TO REPLACE
BALLASTS

- 4 STANDARD TYPES of Amperite Regulators replace over 200 types of AC-DC Ballast Tubes now in use.
- Not to be confused with ordinary dropping resistors. Amperite actually regulates.
- Amperite Regulators are equipped with a patented Automatic Starting Resistor which prevents initial surge and saves pilot lights.
- Amperite AC-DC Regulators; List \$1.00. Amperite Replacements for 2V Battery Set ballasts List \$1.25

WRITE FOR REPLACEMENT CHART "S"

AMPERITE Co. 551 Broadway, N. Y. C.

AMPERITE

SEARCHLIGHT SECTION

"TICKLED"

9,999 servicemen from California to Maine are "tickled" with our coil re-winding service—Prompt service—Low prices.

Send in any defective or good coil for duplication—State make and frequency, if known—Write for coil re-winding bulletin.

Are you interested in a better wide band TRF tuner kit for quality reception or an excellent Frequency Modulation tuner kit? Write for information.

BARBER & HOWARD, Inc.
EAST AVENUE
WESTERLY, RHODE ISLAND
Engineers and Coil Specialists

FREE RADIO CATALOG

ALL RADIO NEEDS
Your nationally known favorites in sets, parts and supplies, public address systems, testers and kits, etc., at lowest possible prices. Write for this big book.

BURSTEIN-APPLEBEE COMPANY
1012-14 McGEE ST., KANSAS CITY, MO.

POSITION WANTED

Man with 25 years experience in phonograph, radio and records business desires connection. Wholesale, retail or with factory promotion. Will travel. Box PW-141, Radio and Television Retailing, 330 W. 42nd St., New York, N. Y.

PHILCO 89

Overloads, poor tone . . . connect 1 meg. resistor from 75 grid to ground.

PHILCO 610

Distorted, low plate voltage on 75 tube . . . replace .1 mfd condenser part #30-4170M.

PHILCO TH-14, TH-16

Station hum at high volume . . . replace condenser #12 in diagram, a 250 mmf mica unit with a 4 mfd electrolytic.

RCA 46x1

Noisy . . . leakage between sections of the filter condenser.

RCA U 123

Intermittent reception . . . 15,000 ohm screen dropping resistor opening at intervals.

SILVERTONE 4790

Weak or dead . . . look for shorted, leaky, or open .00005 mfd mica condenser in oscillator circuit. Suspect this condenser if padder has no effect.

SILVERTONE 6325, 6425

Plate voltage low . . . look for defective 50 ohm resistor in plate circuit of 25Z6G.

SONORA A-11

Intermittent reception . . . volume control lugs shorting to chassis. Insert piece of insulation between lugs and chassis. Tighten volume control nut so control does not shift and short to filter condenser.

SONORA A-11

Noisy when tuning . . . rotor of condenser touches metal shield of 6D6. Glue a small piece of insulation to the chassis at one side of the socket so the tube tilts away from the condenser.

SONORA A-11

Filter condenser fails after short period . . . remove the back of the plastic cabinet as plenty of ventilation is necessary. The ballast resistor is alongside the filter and causes severe overheating.

SOUND MEN WILL WELCOME

New! ATLAS SOUND 'MORNING GLORY'

Double Re-entrant Type Projectors



★ EFFICIENT, COMPACT ★ 100% STORM-PROOF

★ Here you have the ultimate in high acoustic conversion efficiency . . . NEW Atlas Sound "Morning Glory", Projectors and "Dyna-Flux" Permanent Magnet Compression Type Speaker Units. ★ The new projector line offers air column sizes for all public address purposes. Three driver unit models are also available . . . with varied power ratings. ★ You'll welcome this new achievement in speaker design . . . allows the use of super-powered p.a. speakers at a price within your reach.

★ WRITE FOR CATALOG F-40 NOW!



ATLAS SOUND CORPORATION

1449 39th St., Brooklyn, N. Y.
At the Show—Booth 503.

YOU ASKED FOR . . .

QUALITY at a PRICE

Here it is!

Readrite
RANGER

Model
432-A



Only \$17.85 Net

- RED•DOT Lifetime Guaranteed Triplett Meter
- Sockets for All Tubes including new 1.4-volt Miniatures
- Filament Voltages from 1.1. to 110-A Safe-guard Against Obsolescence.
- Precision Indicating Instrument with Two Highest Quality Sapphire Jewel Bearings
- Separate Line Control Meter
- Neon Shorts Test
- Etched Panel of outstanding NEW Design
- Approved RMA Circuit

TODAY'S outstanding tube tester value—a guaranteed quality portable tester at a price you can afford to pay. Checks Octals, Single Ends, Bantam Jr., the 1.4 volt miniatures, Gaseous, Rectifier, Ballast, the High Voltage Series (including 117Z6G) and others recently announced. Direct Reading GOOD-BAD meter scale. Positively will not deactivate 1.4 volt or other type tubes.

The New 1940-41 Line of Readrite Meters and Testers Will be Displayed in Booth 618—Chicago Radio Parts Show.

Write for Catalog—Section 520, College Avenue

READRITE METER WORKS, Bluffton, Ohio

Where You Tell Us...

For, About and By

The writer has been in the retail radio business for 12 years, earning over \$75,000 in that time.

I believe I have accumulated a few ideas that would be valuable to others in the trade.

If I were to pass them along to you on paper would you edit and pay for them if they were acceptable?

CHICAGO

F.B.L.

You bet your sweet life we would! This magazine is for radio retailers who sell or service or both, most of it's text is about their actual experiences and not a few subscribers have demonstrated to us by taking their pen in hand that when it comes to putting practical ideas that really help others sell down on paper no mere reporter can compete with copy written by radio retailers.

Now We'll See

I have a suggestion to make which would make your magazine even more desirable to servicemen like myself.

Take the best monthly service data and compile an annual issue, and watch servicemen go for yearly renewals with this book as a premium, containing the dope they usually have to go looking for through a pile of separate issues.

If you doubt my optimism, publish this and get opinions.

PHILADELPHIA ANTHONY J. DEFRANCO

Good idea, brother. So good, in fact, that we were preparing "Radio Service Shortcuts" when your letter arrived. Hope both of us have guessed right about the result.

Slaps At Schick

In your March issue R. H. Schick writes that he wants you to print photos

of chassis as well as circuits.

Since when can't a serviceman find a part in a radio from the wiring diagram?

Wonder what he would do without

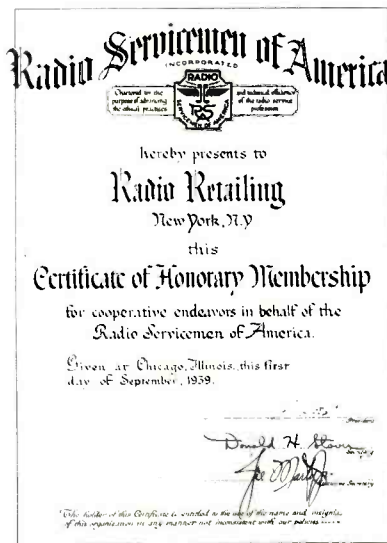

even a diagram?

If I had to look up even a wiring diagram every time I had a radio to fix I would spend more time with my nose among blueprints than I would actually fixing radios.

SALT LAKE CITY RAY ALEXANDER

In answer to the complaint of one R. H. Schick of Kansas City, who says photos as well as wire diagrams should be furnished for finding one's way through a radio circuit let me say that

it is bad enough trying to trace circuits through a midget set without trying to identify parts by checking with a two-by-four photo.

I think it would be really something if manufacturers accurately labelled parts for size, value, etc.

Photos? Phooey!

WILPEN, MINNESOTA FRANK STERLE, JR.

Flowers for Nash

Robert E. Nash's March article about sound rental prices is the best I have ever read. He hit the exact prices I am charging here. Wish there were more who kept at least as high as the suggested minimum prices.

What we soundmen really need is some kind of an Association to play our game for us in an effective way, particularly with the consumer. Something like radio servicemen already have. WEST PHILADELPHIA L. STEWART RIVERS
S & R Radio Service

Mixed Comment

Steinhart (page 72, March) really has sumpin'!

Marion L. Rhodes doesn't seem to value his arm. Like a lot of other chaps. In radio service mostly for fun and unbuttered bread. Never no cake. \$75 to \$100 per week? Not in New York City!

"Tabs for swap." Now that fellow Ward has sumpin'. But how to work it out?

Sure like the stuff you print.

BUFFALO H. BABRISPES

INDEX TO ADVERTISERS - May, 1940

	Page
Aerovox Corp.	50
Airtemp Div., Chrysler Corp.	31
Amperite Co.	71
Atlas Sound Corp.	71
Audio Devices, Inc.	70
Barber & Howard, Inc.	71
Belmont Radio Corp.	Inside Back Cover
Burstein-Applebee Co.	71
Centralab Div. Globe Union, Inc.	54
ClaroStat Mfg. Co., Inc.	46
Columbia Recording Corp.	27
Crosley Corp., The	52, 53, 55, 56, 57, 58
Dayton-Acme Co.	Back Cover
Edison General Electric Appliance Co., Inc.	35
Electrovox Co.	59
Farnsworth Television & Radio Corp.	48, 50, 52, 54, 56, 58
Federal Recorder Co., Inc.	6, 14
Gale Products	33
General Electric Co.	38
General Records	62

	Page
Hygrade-Sylvania Corp.	10
Jensen Radio Mfg. Co.	11
Ken-Rad Tube & Lamp Corp.	62
Mallory & Co., Inc.	P. R. Inside Front Cover, 4
McGraw-Hill Book Co., Inc.	67
Meissner Mfg. Co.	49
National Carbon Co., Inc.	41
National Union Radio Corp.	57
Philco Radio & Television Corp.	36, 37
Pioneer Gen-E-Motor Corp.	59
Quam-Nichols Co.	66
Radiart Corp.	70
Radio City Products Co.	66
Radio Corporation of America.	43
Raytheon Production Corp.	9
RCA Manufacturing Co.	2, 3, 12

	Page
Readrite Meter Works	71
Rider, John F., Publisher, Inc.	59
Searchlight Department	71
Seeburg Corp., J. P.	5
Sentinel Radio Corp.	59
Satchell-Carlson Inc.	64
Simpson Electric Co.	53
Sprague Products Co.	63
Transformer Corp. of America	51
Triplett Electrical Instrument Co.	68
Utah Radio Products Co.	7, 8
Ward Products Corp., The	67
Warwick Manufacturing Corp.	62
Webster Electric Co.	52
Western Electric Co.	55

Although Radio & Television Retailing takes every precaution to insure accuracy, we cannot assume responsibility for an occasional change or omission in the above index.

McGraw-Hill Publishing Company, Inc. Publication Office: 99-129 North Broadway, Albany, N. Y. Editorial and Executive Offices: 330 West 42nd Street, New York, N. Y.



Model
533

THE BABY GRAND MUSIC 'BOX—Here's the biggest value ever in a table model radio phonograph! Tone such as you'd expect only from a far higher-priced set. Two-tone walnut cabinet packed with immediate eye-appeal. Combining a 5-tube Superheterodyne radio and phonograph playing both 10" and 12" records. You can offer this unusual table model at an inexpensive price and still enjoy a profit. Self-starting, long-life phono-motor operates on 110 volt A. C. only. New type crystal pick-up. Clear-tone Dynamic speaker. No aerial nor ground required. AVC. Offers clear, powerful American Broadcast—such as you've never heard in this price bracket. Sure to be one of this season's best sellers and profit-makers. Size, 8 $\frac{3}{4}$ " high, 16" wide, and 13" deep.

Announcing Two New
BELMONT BEST SELLERS

★ Once again Belmont engineering has produced the kind of instruments which you can offer for modern home entertainment at attractive prices and still make profits for yourself. Carefully developed by Belmont's engineering and laboratory staffs, these new BELMONT Best Sellers give the trade the values that make for sales, enthusiastic customers, and profits.

Don't fail to write for prices, discounts, and complete information about the new low-priced, profitable BELMONT table model Radio-Phonograph and BELMONT Radio Phono-Recorder.



Model
797

RADIO PHONO-RECORDER—Think of it—radio recording circuit, hi-fidelity phonograph, microphone recording, simultaneous radio and microphone recording, and a two band receiver with automatic tuner—all in one instrument housed in a beautiful console cabinet at a price that is sure to make sales!

7-tube skip-band Superheterodyne, broadcast band 540 to 1840 K. C. and 5.6 to 18.3 M. C., tone control, 10" speaker, built-in loop antenna, six disappearing buttons, automatic tuner. Five controls—manual tuning, band switch and tone control; two separate volume controls provided, which control microphone and radio. These controls provide means of mixing radio and voice recording at will.

LIGHT-O-MATIC type level indicator warns operator against overloading record cutter. Crystal cutter and play-back arms are perfectly matched.

The Crystal microphone, with seven-foot cable and desk stand may be easily removed from base for use as hand-type mike and easily replaced.

Size, 33" high, 31" wide, 15 $\frac{1}{2}$ " deep.

BELMONT RADIO CORPORATION

1257 FULLERTON AVE. CHICAGO, ILL.



Cable Address
Belrad

Model 600

DACO RADIOMETER

"The Master Instrument"

DACO engineers have now developed the only complete instrument to service **ALL RADIOS-TELEVISION-SOUND**

amplitude } modulations are all
frequency } very simple for this
video } great instrument

The magnificent beauty of this remarkable instrument encloses built-in synchronization of signal tracer RF-IF amplifier—electronic volt ohm milliammeter—oscilloscope of wide range—sweep generator—sweep amplifier—audio and supersonic frequency oscillator—fundamental RF-IF oscillator—loud speaker and all internal and external analysis.

**OPENS NEW FIELDS OF SERVICE
INCREASES EFFICIENCY OF SHOP
PROTECTS PROFESSIONAL STANDING
SMALLER SPACE — LESS TIME**

**DIGNIFY YOUR SHOP—BE THE FINEST
SERVICE IN YOUR COMMUNITY AND
INCREASE YOUR PROFITS**

PRICE WITH CABINET \$194.90 PRICE FOR RACK PANEL \$179.90

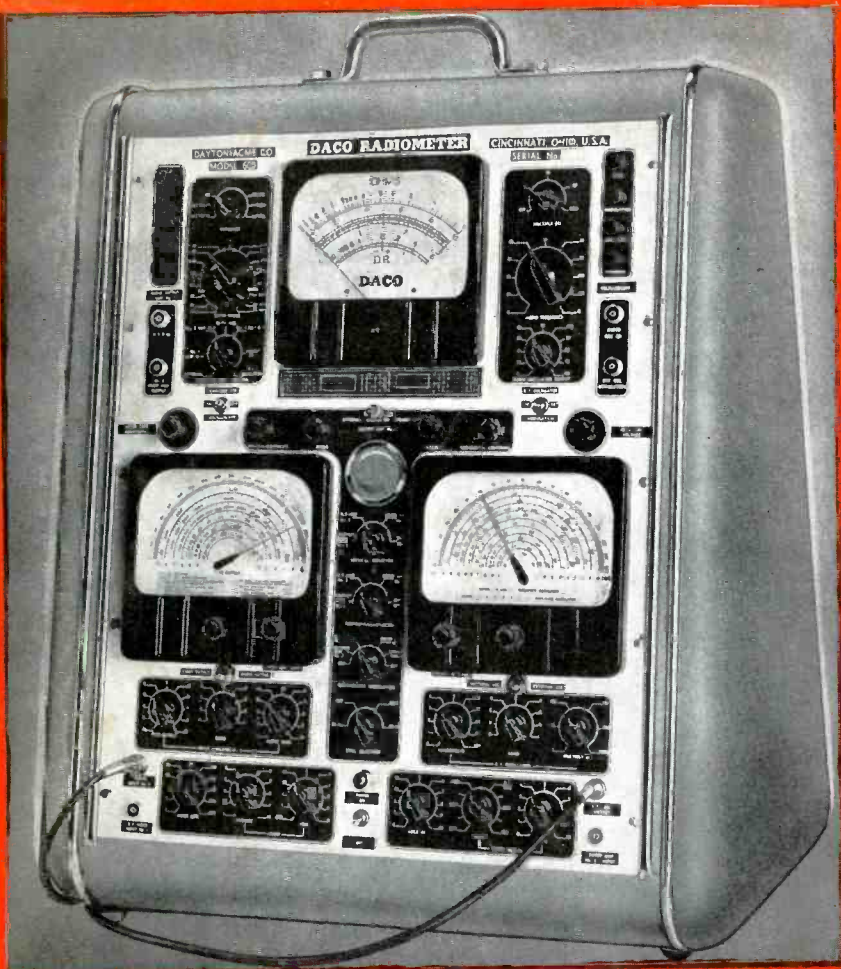

HUNDREDS OF FEATURES include 7" meter—7" dials degree scales both ends, 1,000 volts AC-DC up to 10,000 volts if wanted, resistance range to 100 megohms—DB range —20 to +86—audio supersonic 20 to 150,000 cycles—RF-IF oscillator 9 bands AM-FM-video range 50 KX to 100 MC, calibrated output attenuator, direct reading in microvolts — oscilloscope, selective positioning of hor. and vert. deflector plates, cathode ray modulation—sweep generator range 10 to 25,000 cycles with sync. selector and lock-in control—sweep amplifier also used as separate low gain video amplifier—internal 60 cycle calibrated voltage—complete signal tracer of 6 bands and video amplifier, selection for AM-FM and television, amplifier gain internally calibrated input through constant capacity attenuator.

BUILT TO LAST FOR MINUTE PRECISION IN—SERVICE—LABORATORY—PRODUCTION

Beautifully streamlined iridescent gray or black wrinkle finish cabinet, black and polish silver finish panel, 19" wide x 24 1/2" high, designed rack panel if desired. Instrument 32" high x 24" wide x 16" bottom depth x 7" top depth. Heavy chrome handle—chrome trim strips join panel and cabinet.

MODEL 303CT
IMPERIAL
COUNTER MODEL

DACO TUBE TESTER TUBE SELLER

A real companion to the Radiometer.

DACO again has accomplished the almost impossible task by automatically operating red "replace" and green "good" lighted windows simultaneously with this full size 7" meter—it really convinces your customers and increases tube sales.

Tests all tubes—tests all elements separately—tests under proper power load—obsolescence proofed DACO-Dayrad circuit—ask about our four year guarantee against wear or obsolescence.

THE MOST BEAUTIFUL TESTER OF ALL, with DACO new double column lighted fast rotary index chart, black and silver panel, cabinet 16" x 16" x 6" high x 3 1/2" high, chrome trim.

PRICE WITH LIGHTED WINDOWS \$44.90 PRICE WITHOUT LIGHTS OR PORTABLE MODEL \$34.90 BEAUTIFUL BLACK LEATHERETTE PORTABLE CASE

Choice of Gray—Black or Blue colors



DAYTON ACME CO.

2329 GILBERT AVE

CINCINNATI, OHIO

See your jobber or write
Tube testers \$19.90 to \$59.90
and full line other radio equipmt.

DACO complete line
is the **WORLD'S COMPLETE LINE**

Export Division

646 N. Michigan Ave., Chicago, Ill., U.S.A.

Cable Address "COREXCO"

Dayton Acme Co.

Please send information

- Radiometer
- Tube seller
- Other tube testers
- Other equipmt.
- Time payment
- Rebuilt equipmt.

Name

Address

City

State